

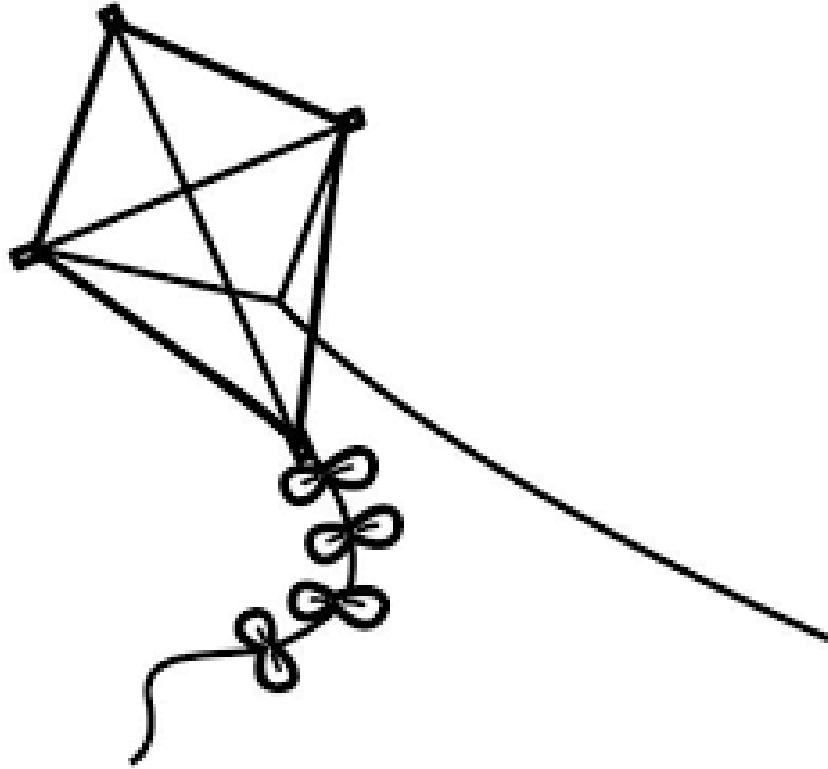

Nombre _____

Curso _____

cometa



Pica

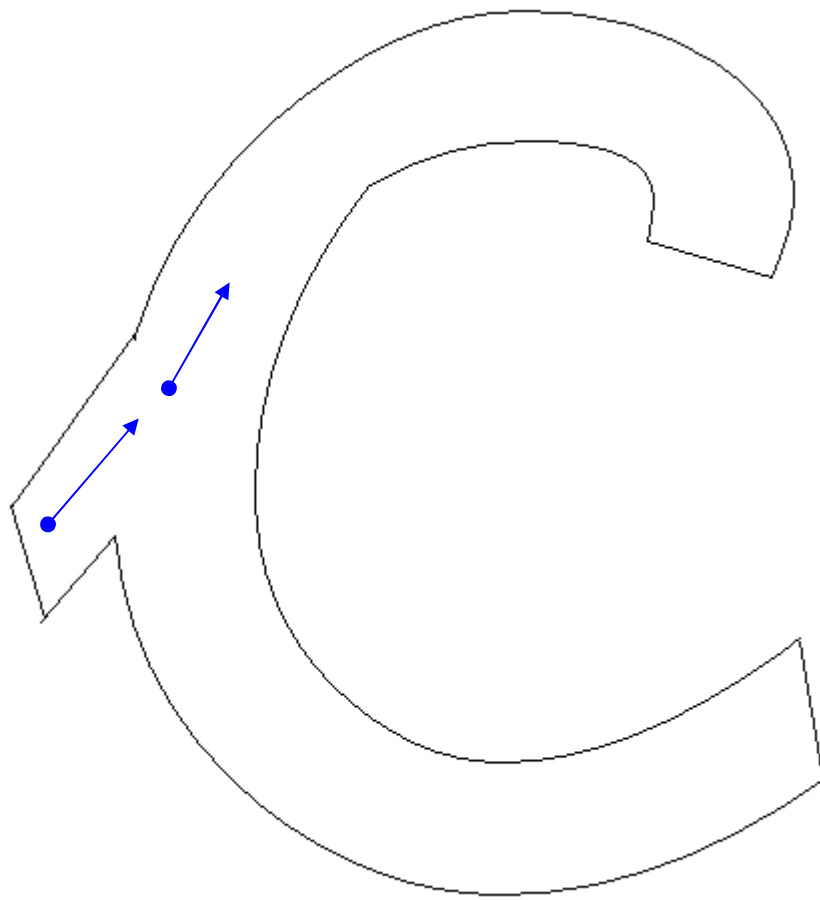

Colorea los dibujos cuyo nombre contenga el fonema "c"

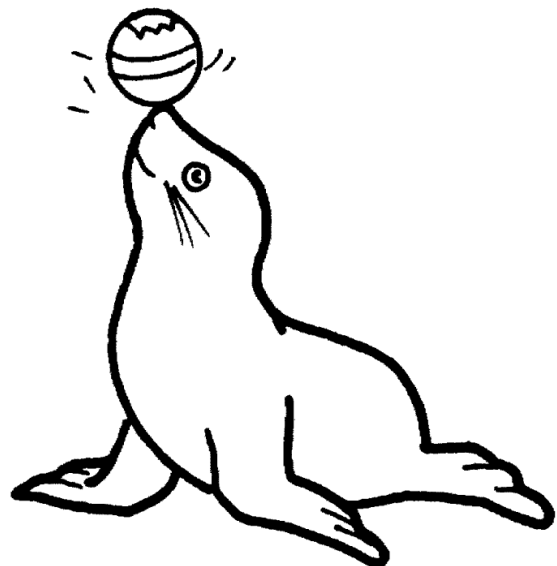
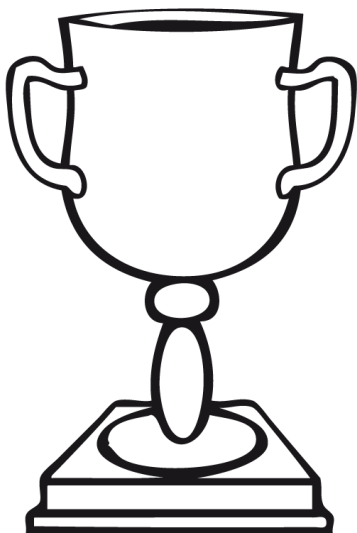
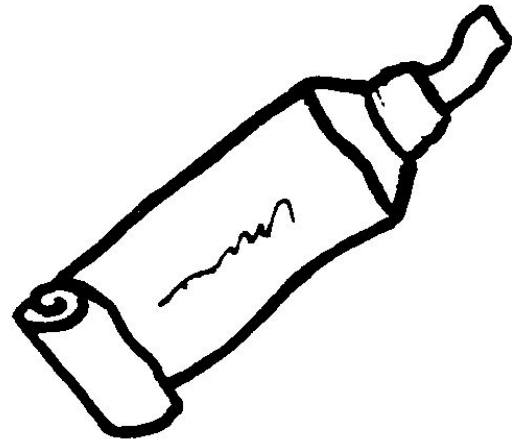
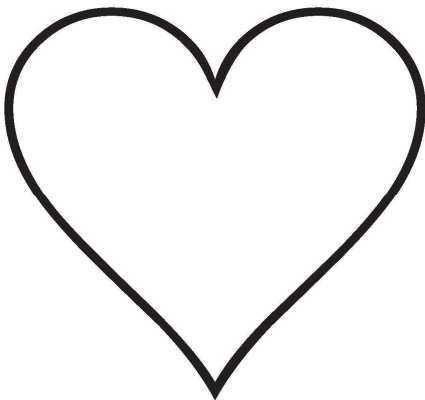
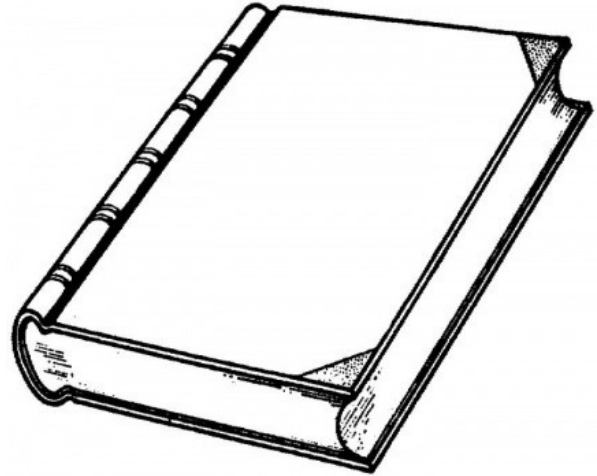

C

cccccccccccc

c

c

C

Lee y copia:

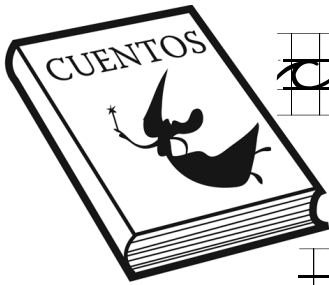

cuentos

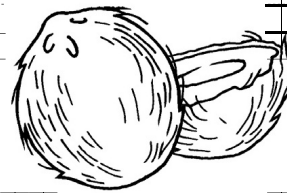

coco



camisa

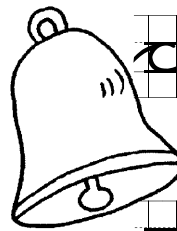

campana

Lee y completa con c:

P_a _ o _ ome no _ o _ o _ o

_ amila _ amina sola.

_ ata usa _ amisión.

Mamá _ uenta _ uentos.

Tacha la letra c:

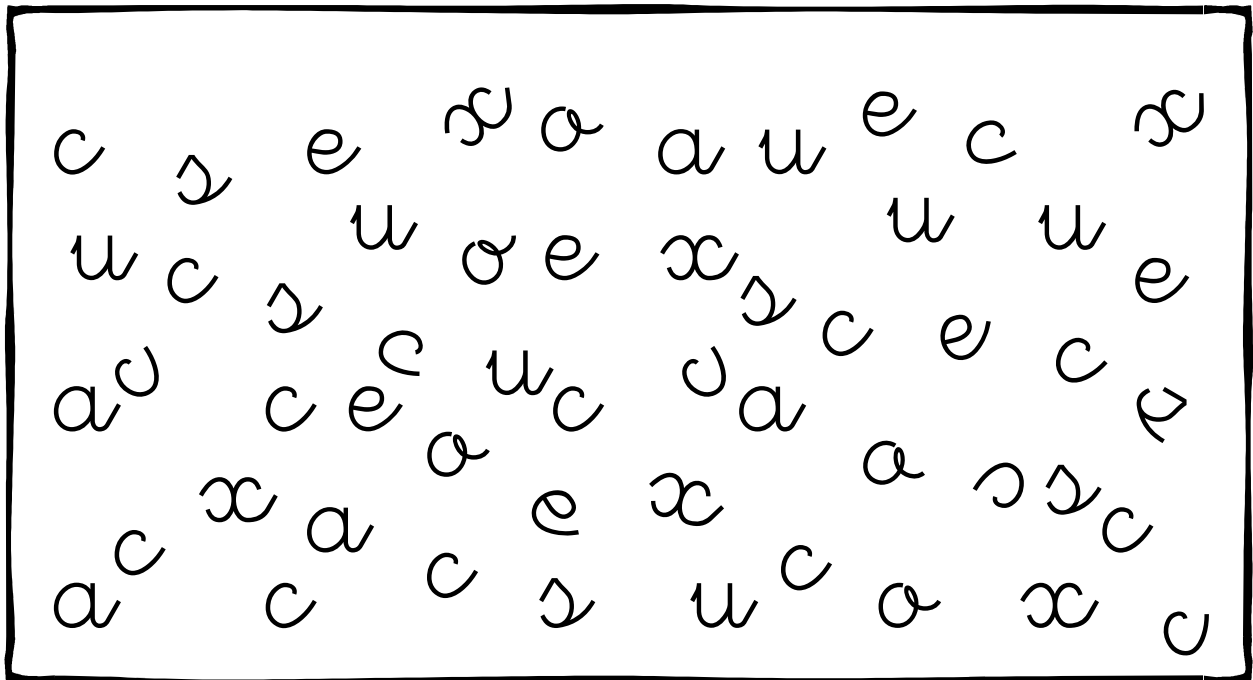

Ordena las frases:

tomate. Come con pasta

Two sets of handwriting practice lines, each consisting of a top line, a middle line, and a bottom line, with a grid of small squares in between.

Casti pastas. bebe come y café

Two sets of handwriting practice lines, each consisting of a top line, a middle line, and a bottom line, with a grid of small squares in between.

Copia:

c c c c c c c c

c c c c c c c c

o o o o o o o o

o o o o o o o o

ca ca cu ca ca cu

Copia:

Ca Ce Cu Ca Ce Cu

Ca Ce Cu Ca Ce Cu

cana cometa cuna col

Peco cose la camisa.

Candela toma cacao.

queso

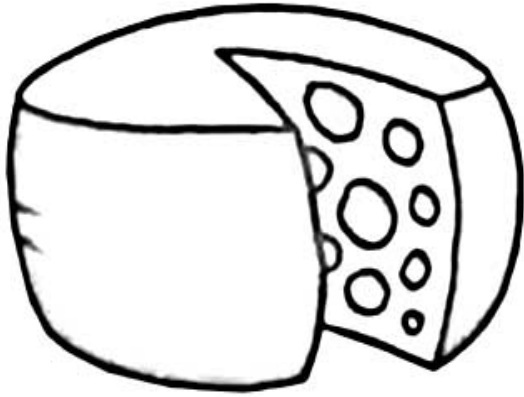

Pica

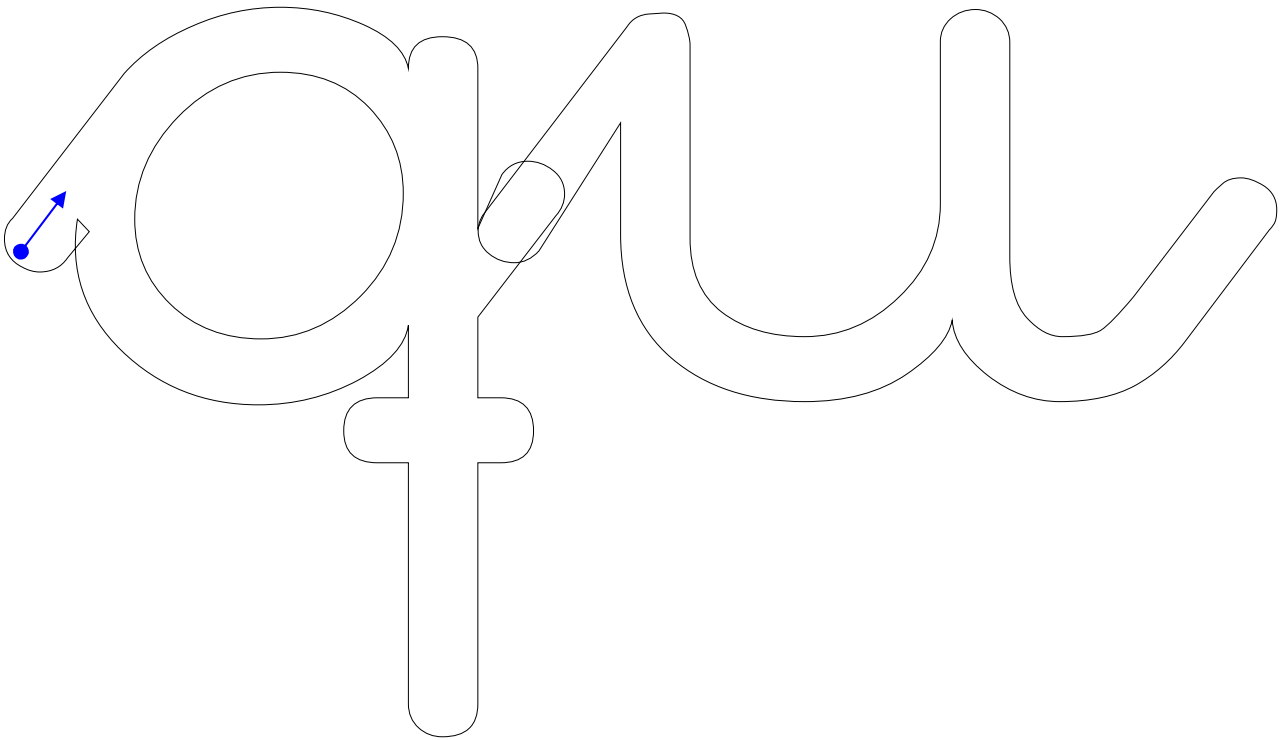

qu

ququququ

qu

qu

Qu

Lee y copia:

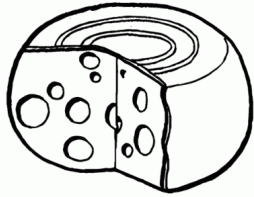

queso

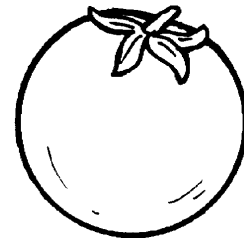
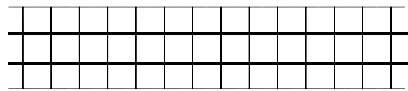

tomate

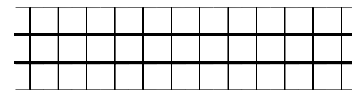

paquete

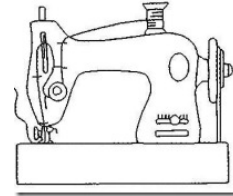
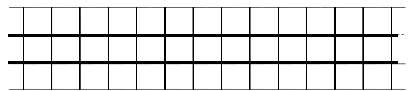

máquina

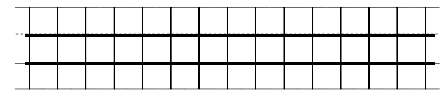

Lee y completa con qu:

Ra _ _ el come _ _ eso.

Le ricó un mos _ _ ito.

_ _ i _ _ e usa _ _ imono.

Pa _ _ i tiene un pa _ _ ete

Completa las frases:



Este ratón come



Esa casa se



El cartero le

dio un



Natalia cose con

la

Copia:

qu qu qu qu qu qu

qu qu qu qu qu qu

Qu Qu Qu Qu Qu Qu

Qu Qu Qu Qu Qu Qu

que qui que qui que

que qui que qui que

Copia:

Que Qui Que Qui Que

Que Qui Que Qui Que

quiesce queso quieto

Quique busca el queso

Aquiles come caquis.

Copia:

Te doy un paquete.

Te doy un paquete.

Le ricé un mesquite.

Le ricé un mesquite.

Paquita esquia aquí.

Paquita esquia aquí.

ratón



Pica

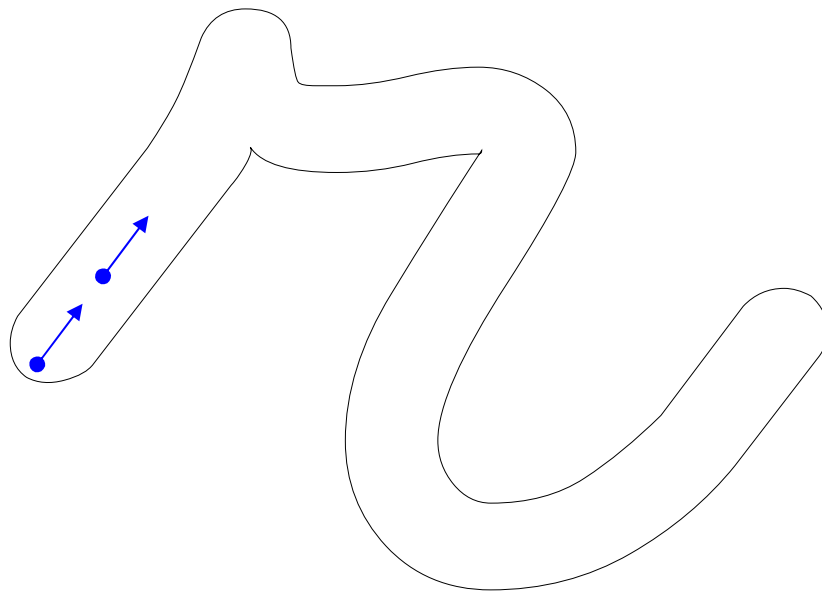

Colorea los dibujos cuyo nombre contenga el fonema "r fuerte"

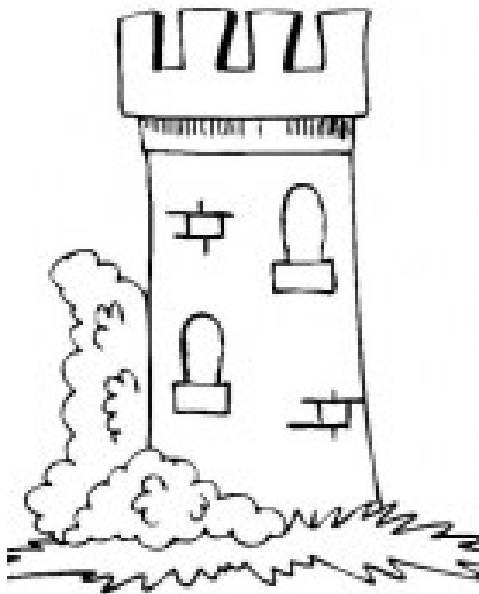
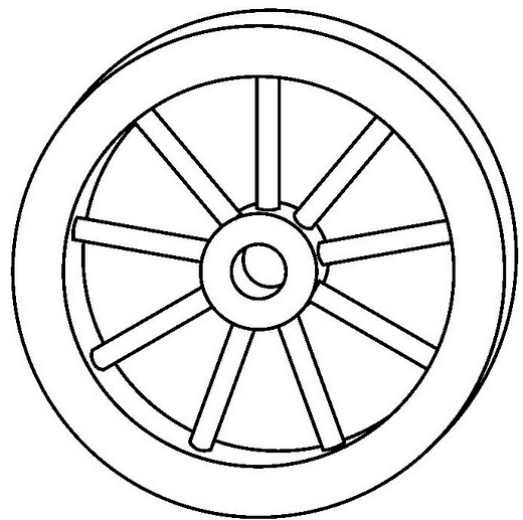
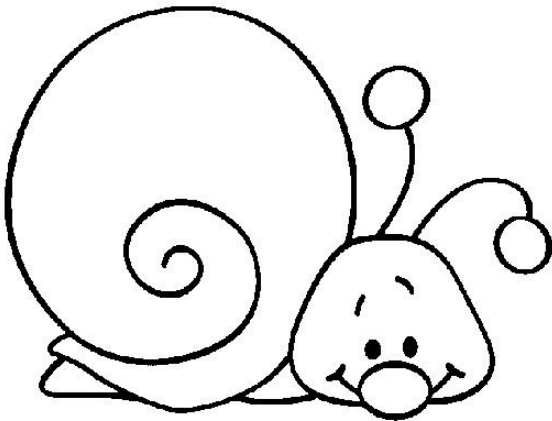
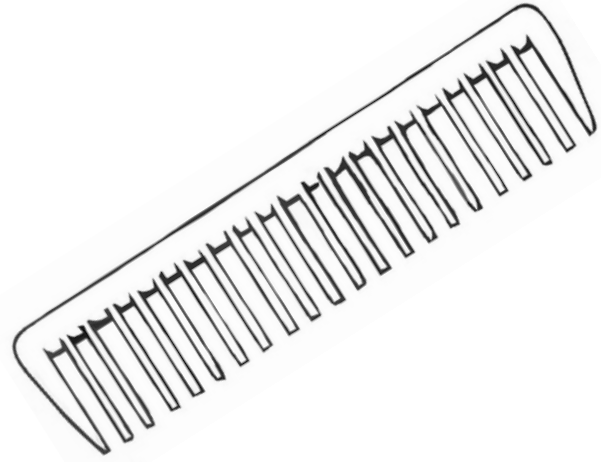

r

r r r r r r r r r r

r

r

R

Pon lo que corresponda:

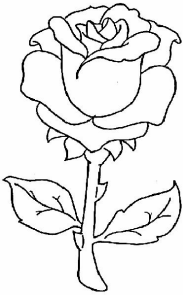
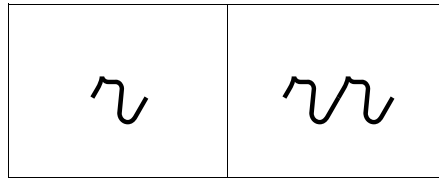

rosa

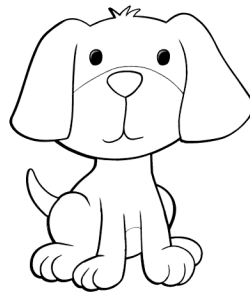

perro

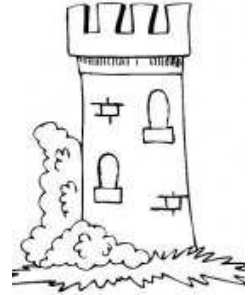

torre



ropa



ramo

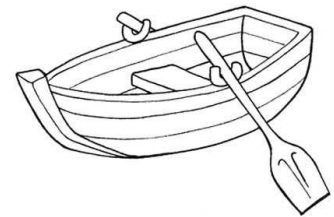

remo



frase

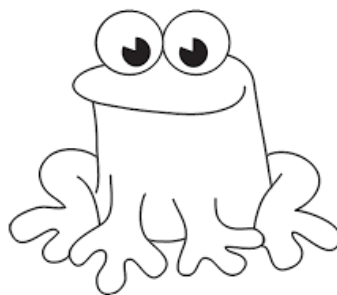

rana



carro

Soluciona el crucigrama:

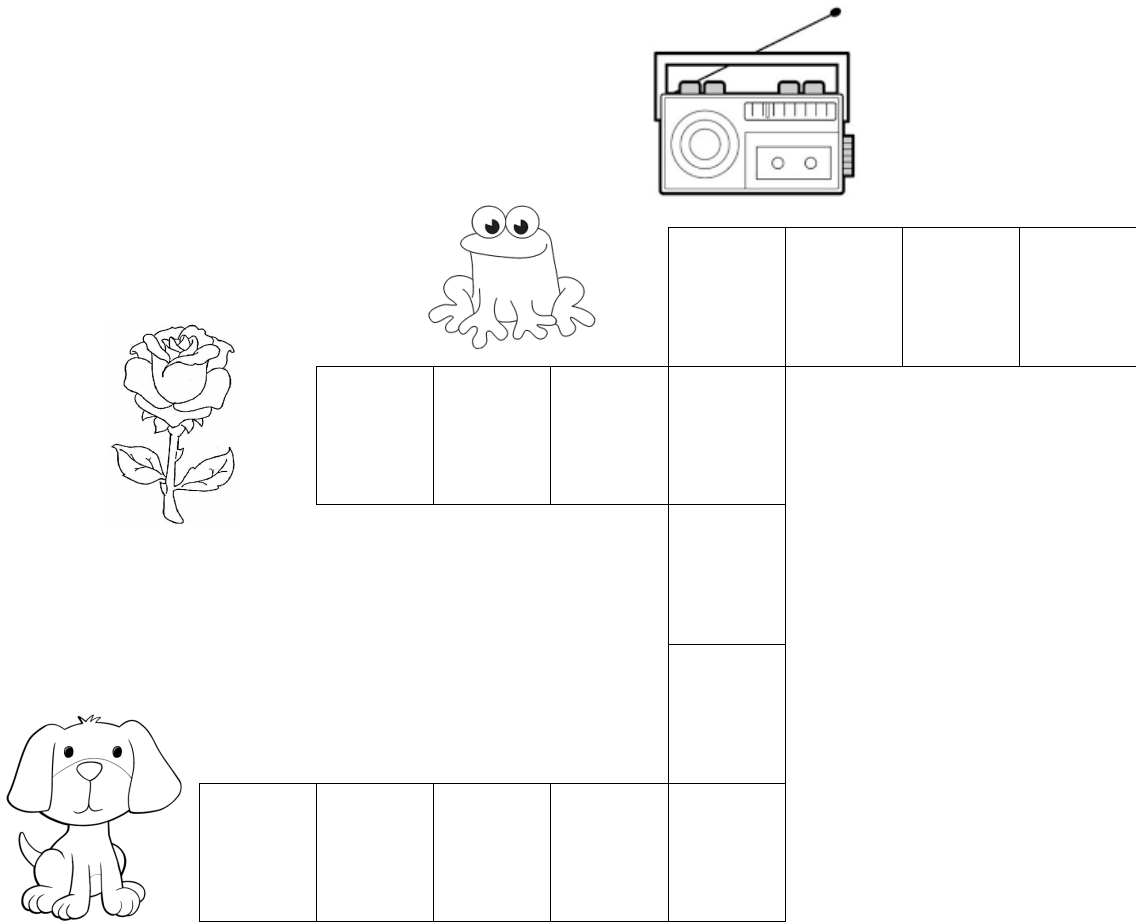

Coloca las letras:

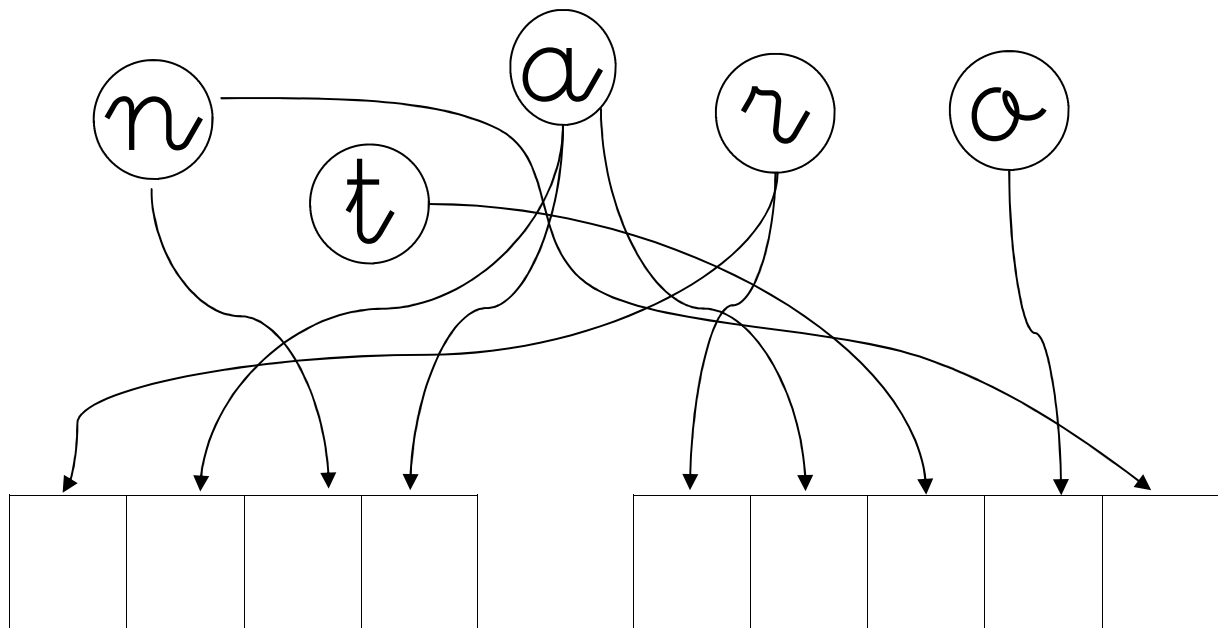

Repasa:

r r r r r r r

r r r r r r r

R R R R R R R R R R R

R R R R R R R R R R R

ra re ri ro ru

ra re ri ro ru

Copia:

rana rosa ríe remo

resta ropa rubeta red

Rosa sube la rampa.

Enrique corre rápido.

Rafa rifa un rubí.

El carro está roto.

mariposa

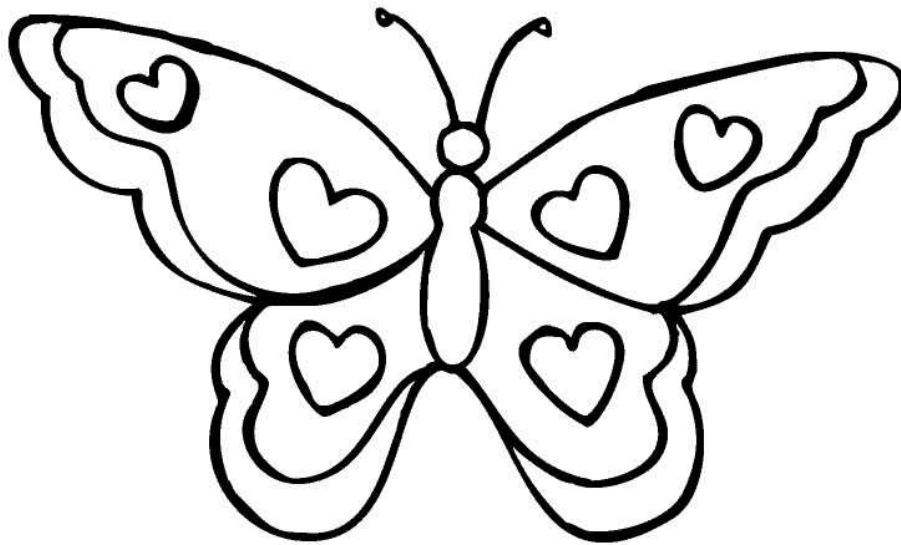

Pica

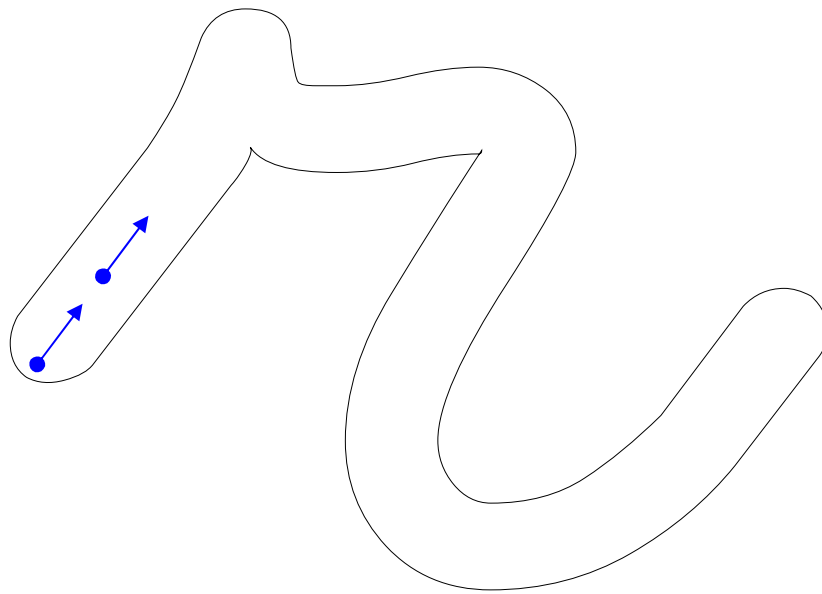

Colorea los dibujos cuyo nombre contenga el fonema "r suave"

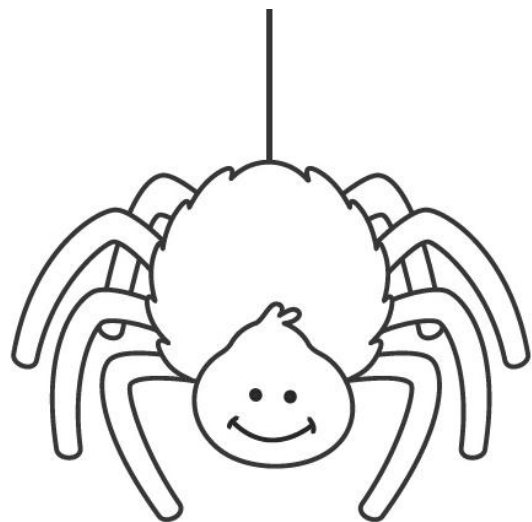
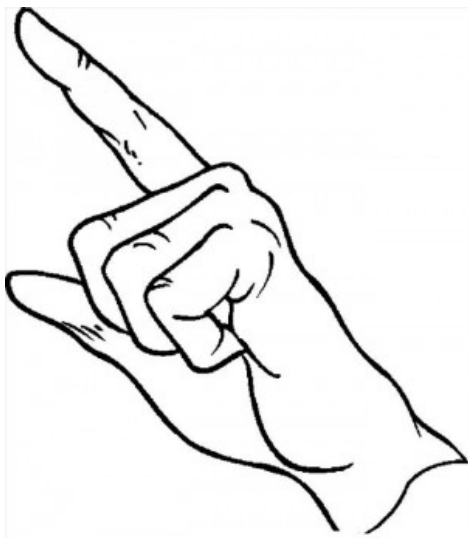
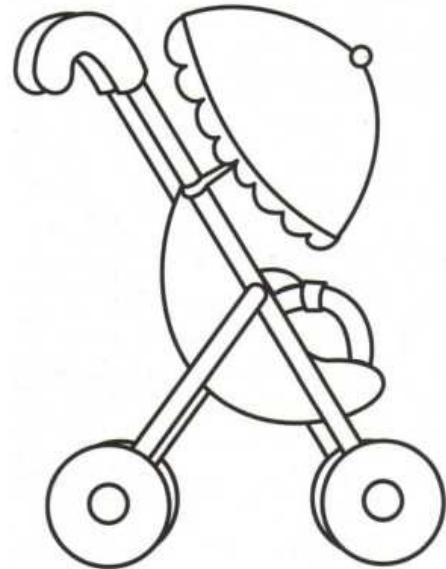
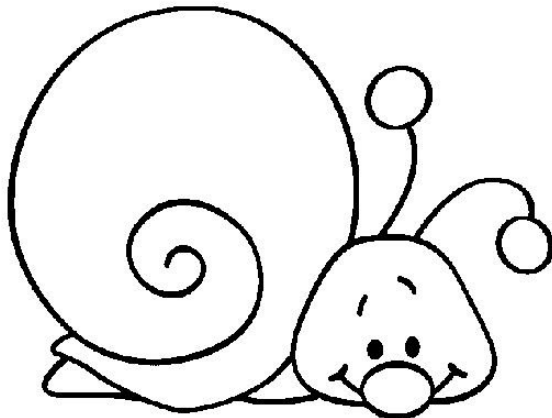
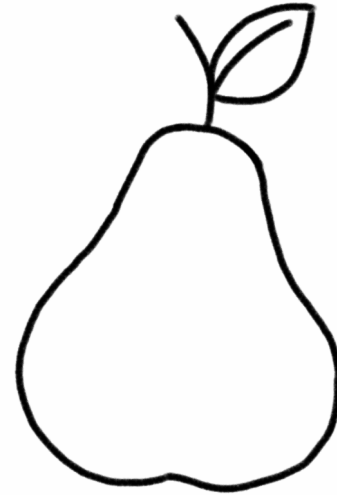
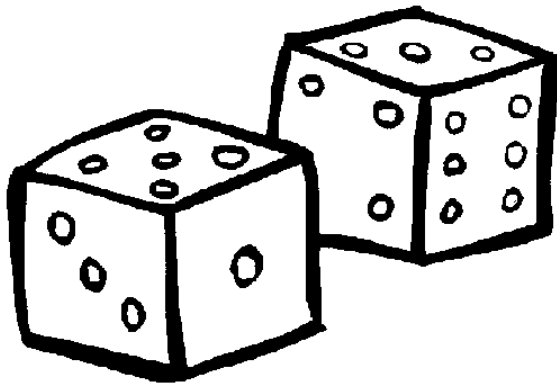

Rodea la palabra igual:

<u>cara</u>	capa	cana	casa	<u>cara</u>
pera	pena	pela	pesa	pera
aro	aro	amo	aso	ato
coro	corro	cono	coro	como
carta	carpa	casta	canta	carta

Completa y lee:



La _____ nada en

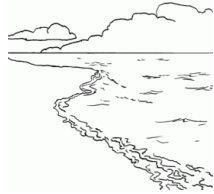

el _____.

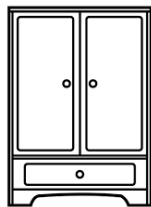

Ese _____ tiene

dos _____.

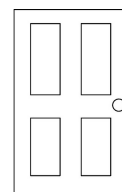

Copia:

or er ir ur ur

or er ir ur ur

morado verde puerta

tesoro pera mariposa

Marta mira la mora.

Mario corta la pera.

Copia:

Marta parte sandía.

Dario y Martin ríen.

Una mariposa verde.

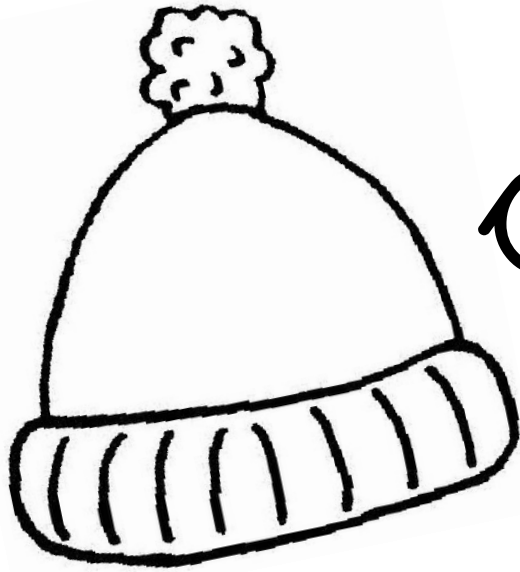

gorro

Pica

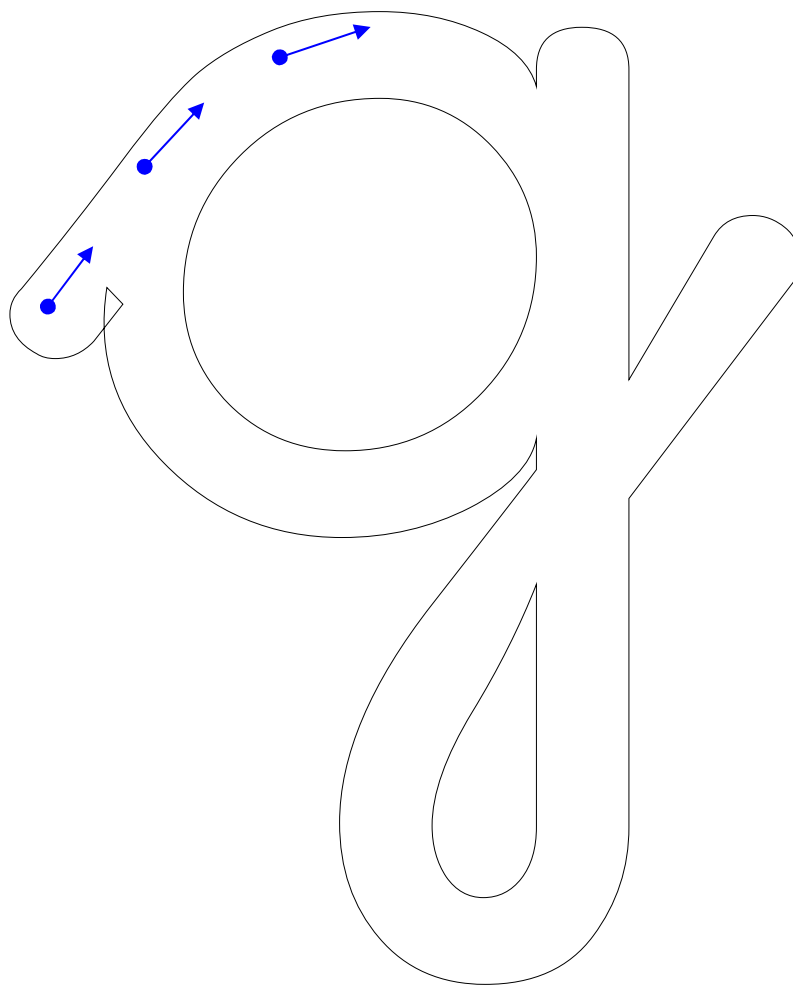

Colorea los dibujos cuyo nombre contenga el fonema "q"

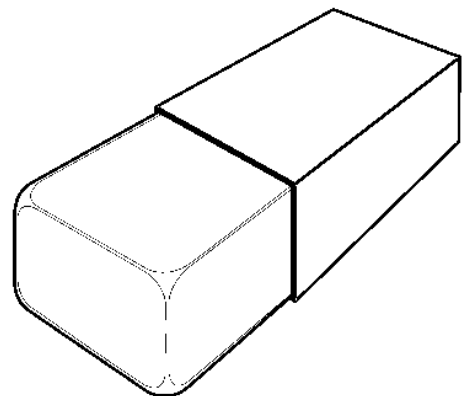
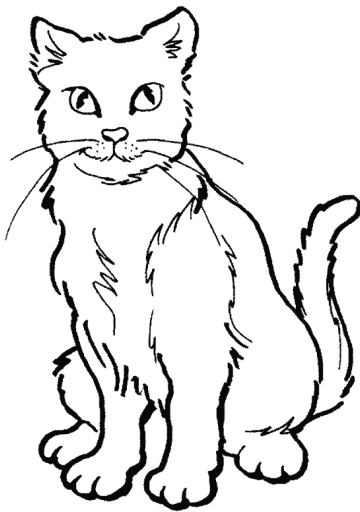
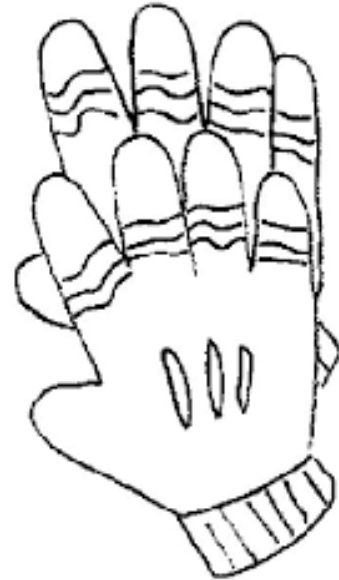

g

g g

g

g

G

Elige la palabra y escribe:

paraguas



gorro

agua

gorro

lago

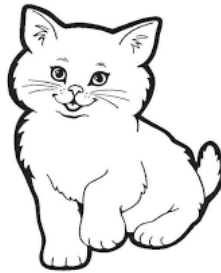

gota

agua

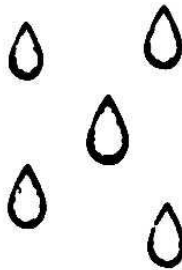

gusano

gato



garras

guantes

goma

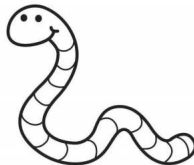

espiga

gafas



Dibuja. Rodea ga - go - gu

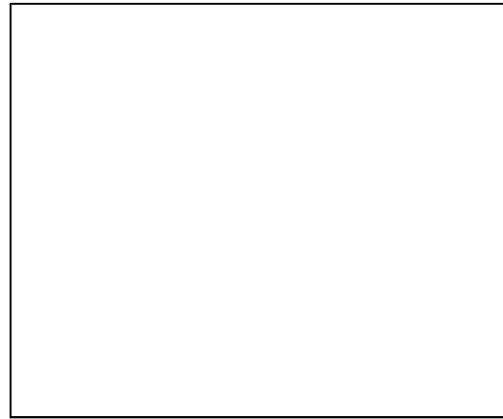
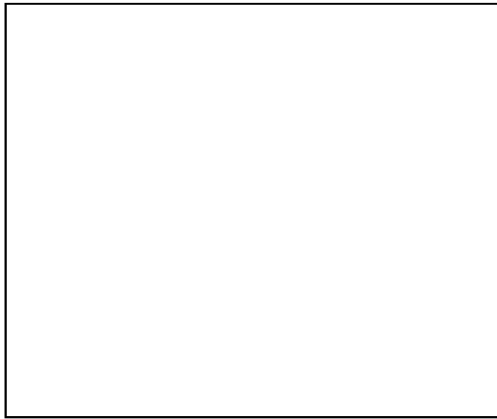

Un gato con botas

Un bote de pegamento



Una goma de borrar

Un mago

Escribe palabras con ga, go, gu.

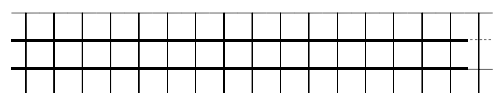
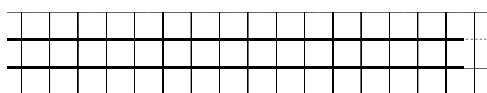
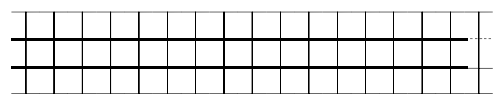
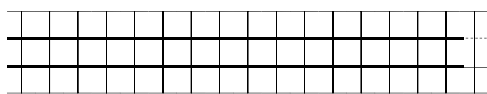
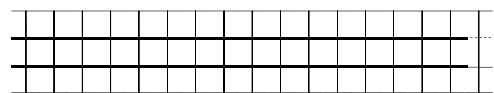
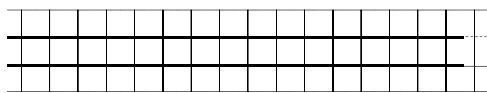

Copia:

g g g g g g g g

g g g g g g g g

o o o o o o o o o o o

o o o o o o o o o o o

ga ga gu ga ga gu

Copia:

Ga Ga Gu Ga Ge Gu

gato goma gusano

El ganó una guerra.



Pica

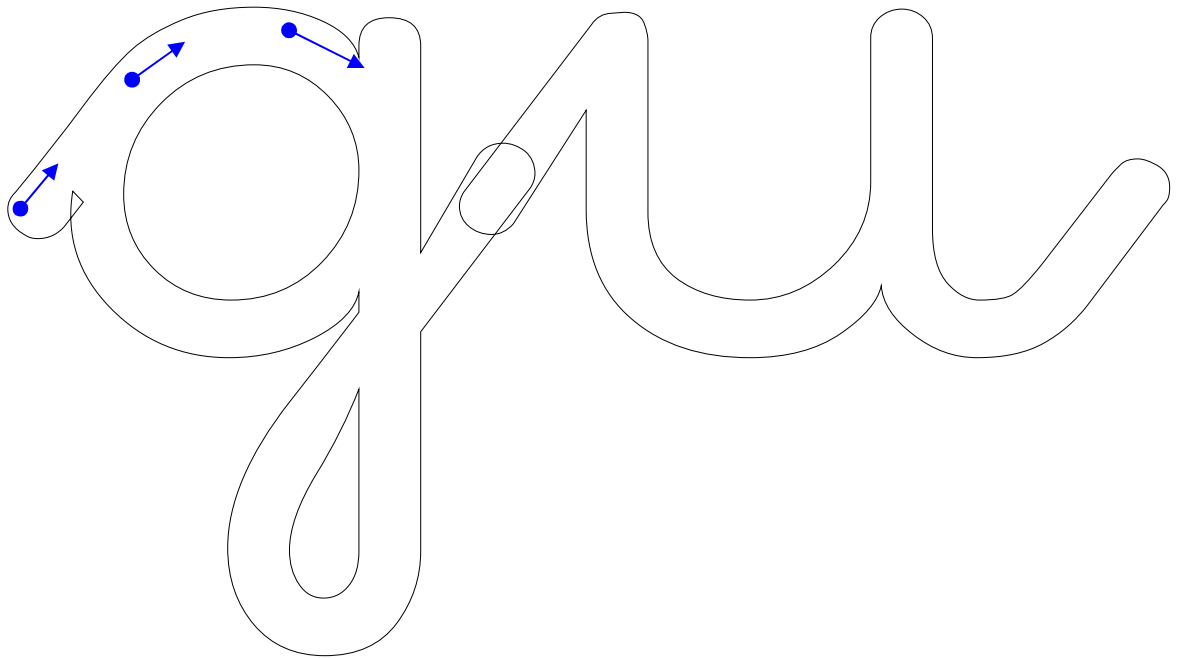

Dibuja. Rodea que - qui

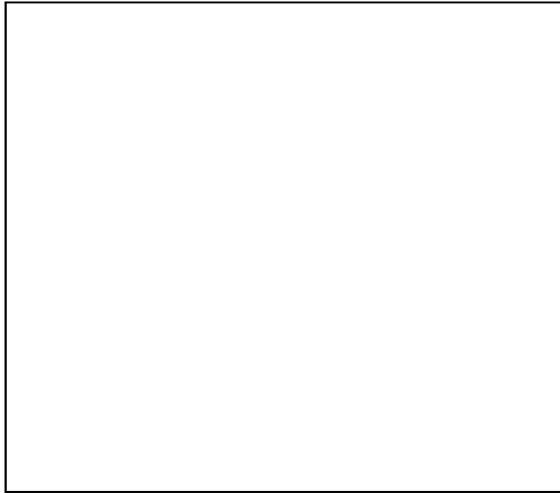

Un guerrero

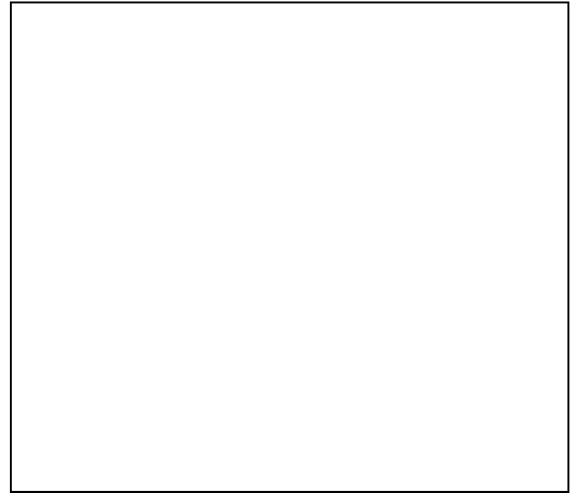

Una guitarra



Un águila



Una manguera

Escribe palabras con que, qui.

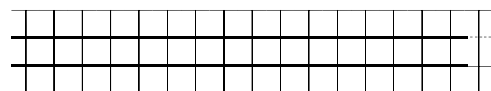
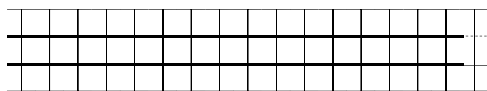
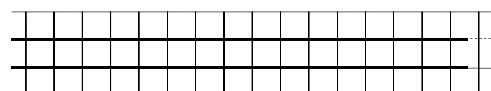
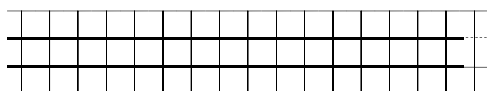

Clasifica:

manquera

gota

gafas

quisante

águila

amigo

guerrero

relámpago

guitarra

Se escriben con g	Se escriben con gu

Colorea y repasa:



Guillermo riega a Águeda y a Miguel con la manquera.

Copia:

que qui que qui que

que qui que qui que

Que Qui Que Qui Que

guitarra guiso águila

Copia:

guernardo guernario

Quisé los quisantes.

Ahí hay cinco quindas

pingüino

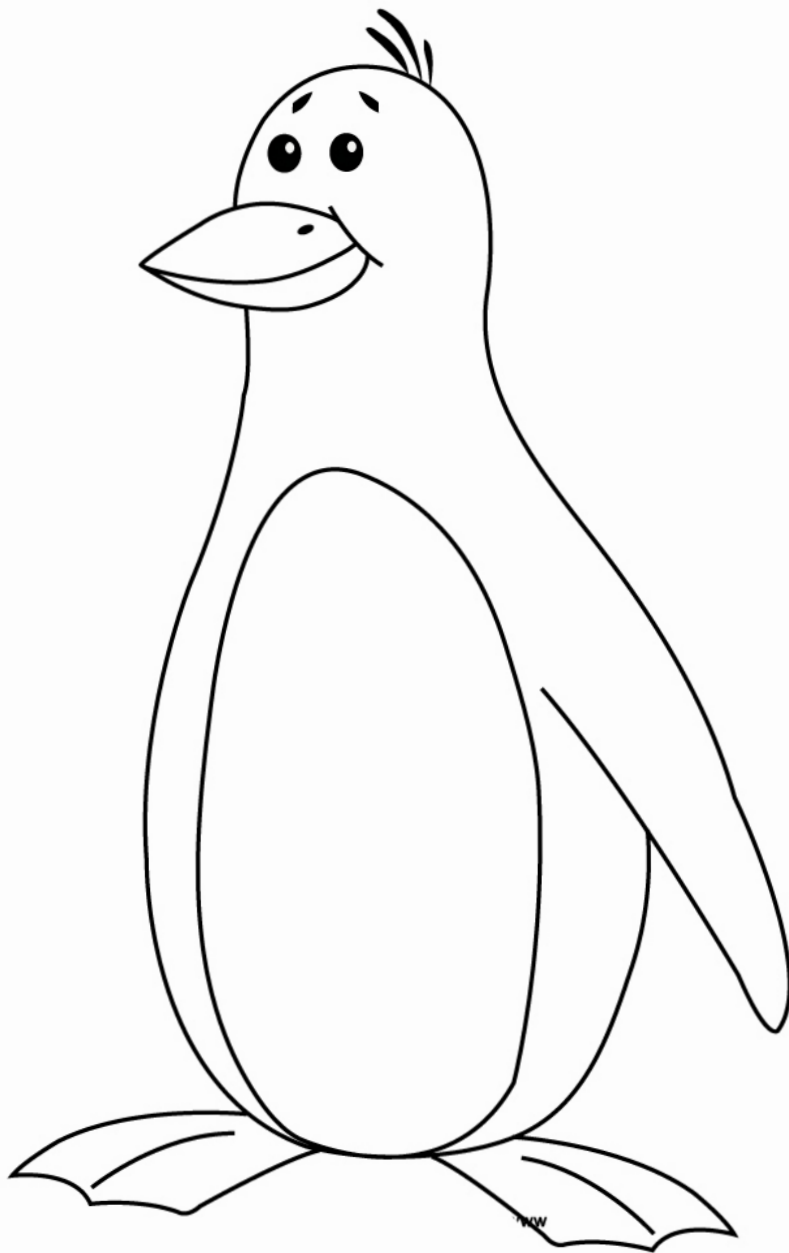

gü

gü

gü

gü

Gü

Rodea

güe

güi

Güe

Güi

El pingüino Güino



El pingüino Güino vivía con su familia en el Polo Sur. Pero ahora vive en el congelador de mi nevera. Por la mañana sale para visitar a su amiga la cigüeña Güeña. Por la tarde le gusta hacer piragüismo en los desagües de la ciudad.

Lee y copia:



cigüeña

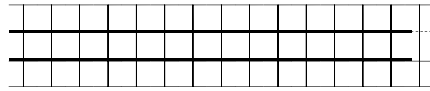

pingüino

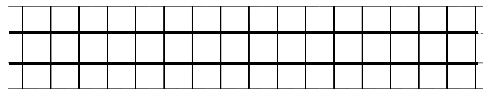

paragueros

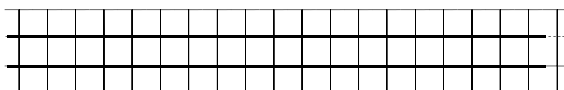

desagüe

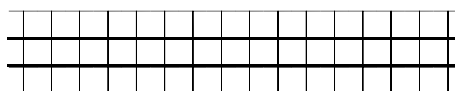

Copia:

güe güi güe güi güe

güe güi güe güi güe

Güe Güi Güe Güi Güe

pingüino paraguero

Copia:

agüita cigüeña Cúrejar

Unos paraguiteros rotos

Veo un pingüino.

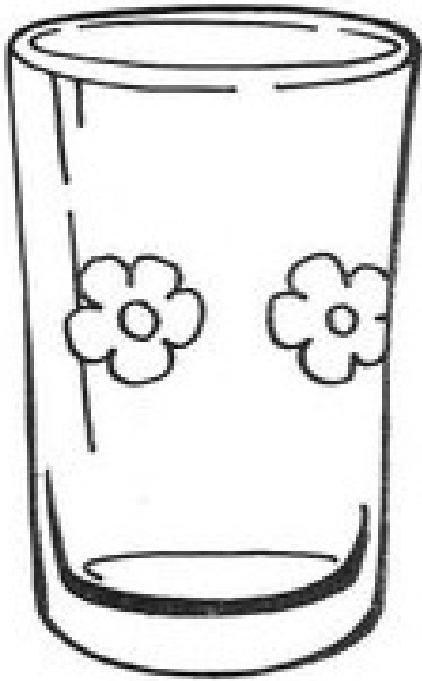

vase

Pica

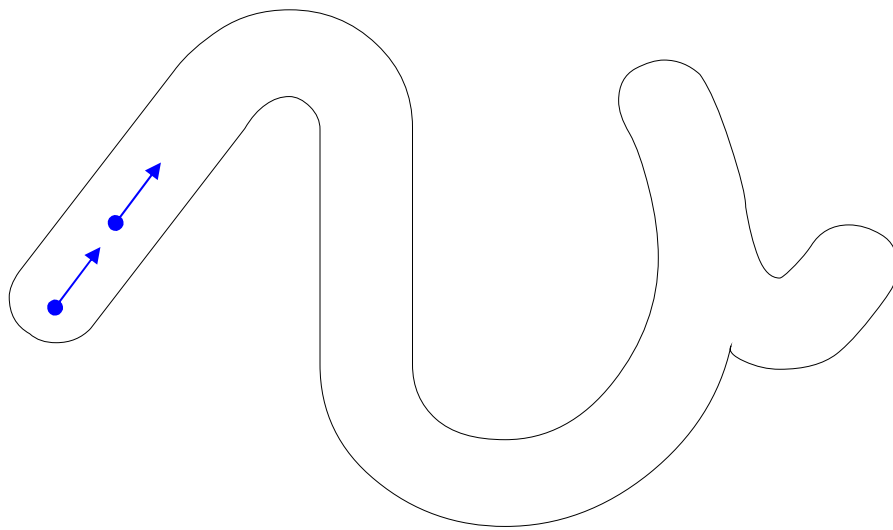

Colorea los dibujos cuyo nombre contenga el fonema "v"

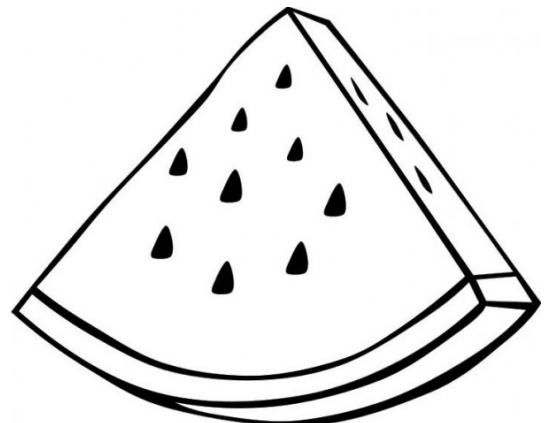
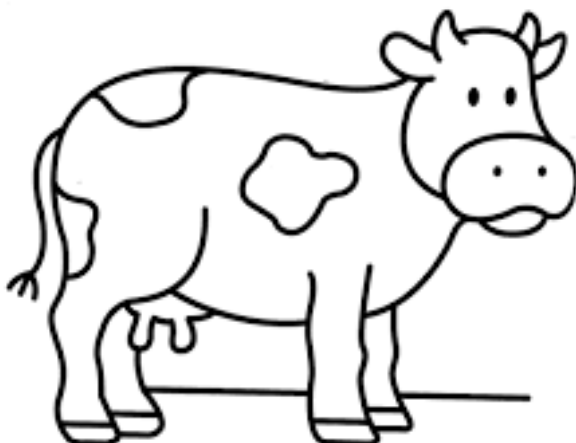
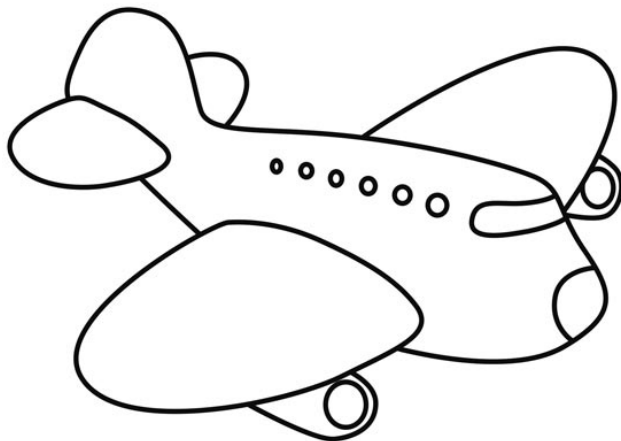

Dibuja.

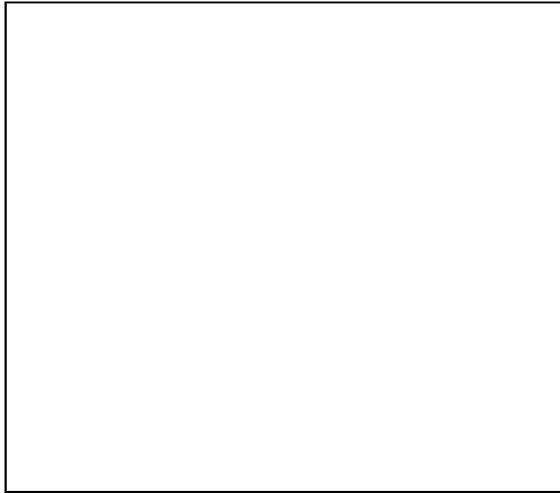

Una vela

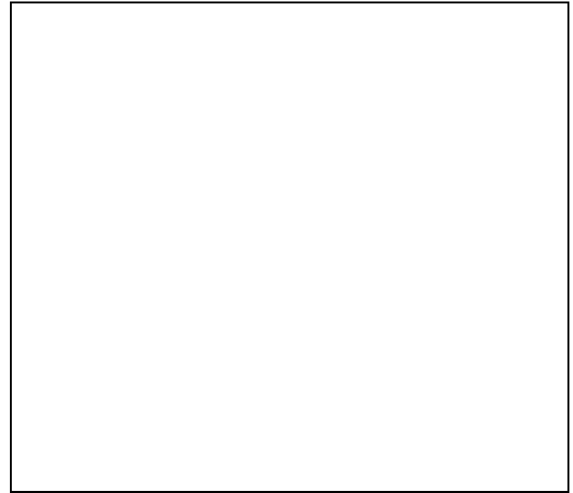

Un ave volando



Una avioneta



Un vaso de vino

Escribe palabras con v.

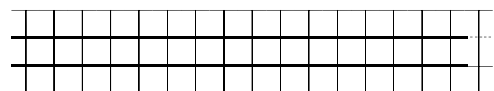
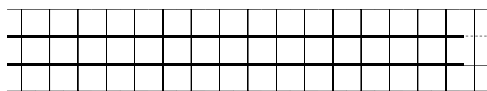
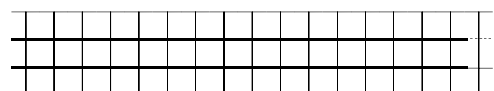
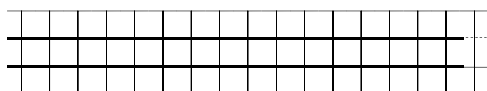

Elige las palabras adecuadas:

nuevo

vaso

vida

ave

velo

avión

vía

nueve

vestido

vela

ventana

vino

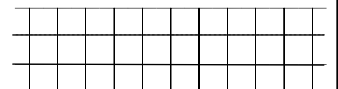
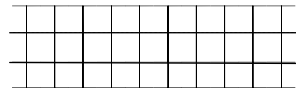
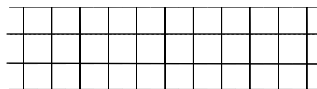
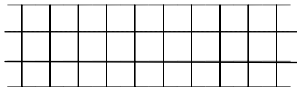
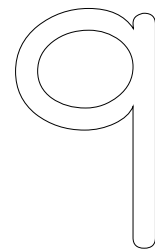
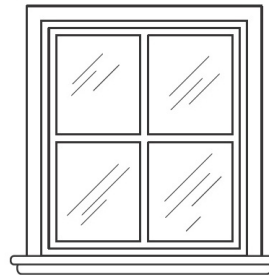
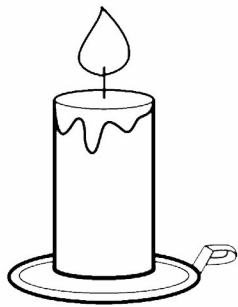

Escribe frases con:

vaso

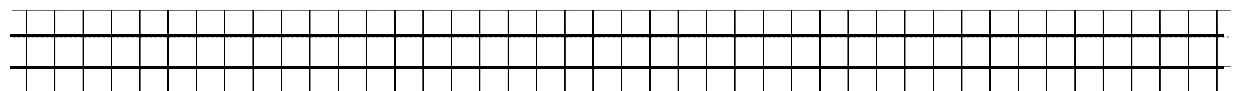
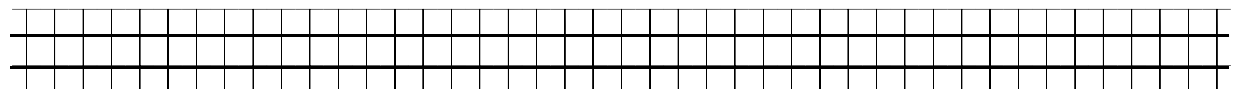

vestido

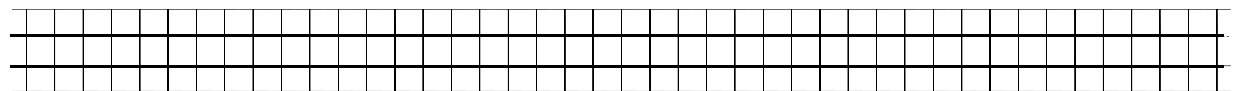
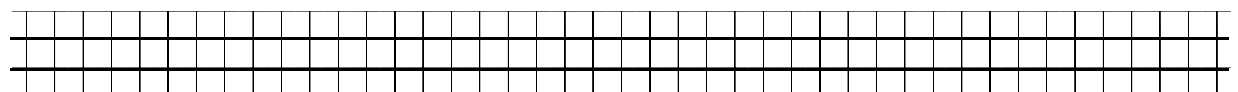

Completa:



bombón

	v		
--	---	--	--

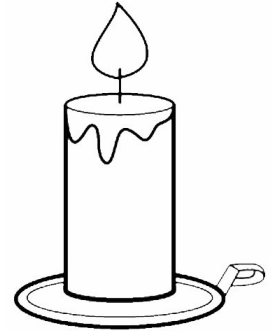

vela

b			b		
---	--	--	---	--	--

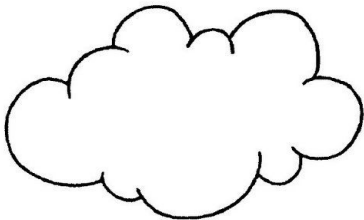

nube

		b	
--	--	---	--

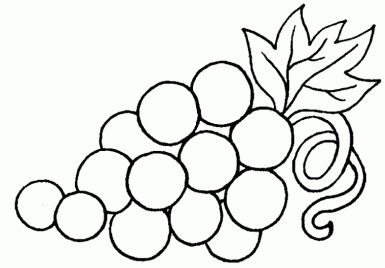

uvas

				v					
--	--	--	--	---	--	--	--	--	--



bota

v			
---	--	--	--

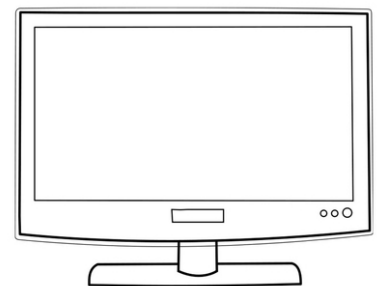

televisión

b			
---	--	--	--

Completa:



_ate

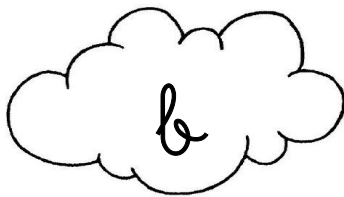

_ata

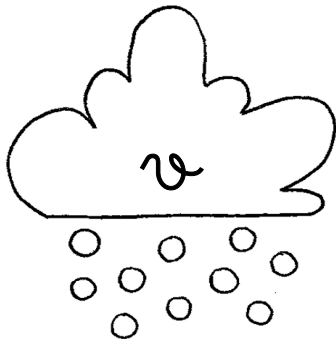

_asa



u_as



nie_e

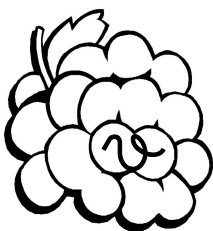

nu_e

Repasa:

re re re re re re re

re re re re re re re

v v v v v v v v v v v

v v v v v v v v v v v

ra re ri ro ru

ra re ri ro ru

Copia:

vase vela vino vela

avión tiovivo suave ve

Violeta bebe en vaso.

En navidad ase nave.

Silvia vive a mi lado

Ana pinta la ventana.



niño

Pica

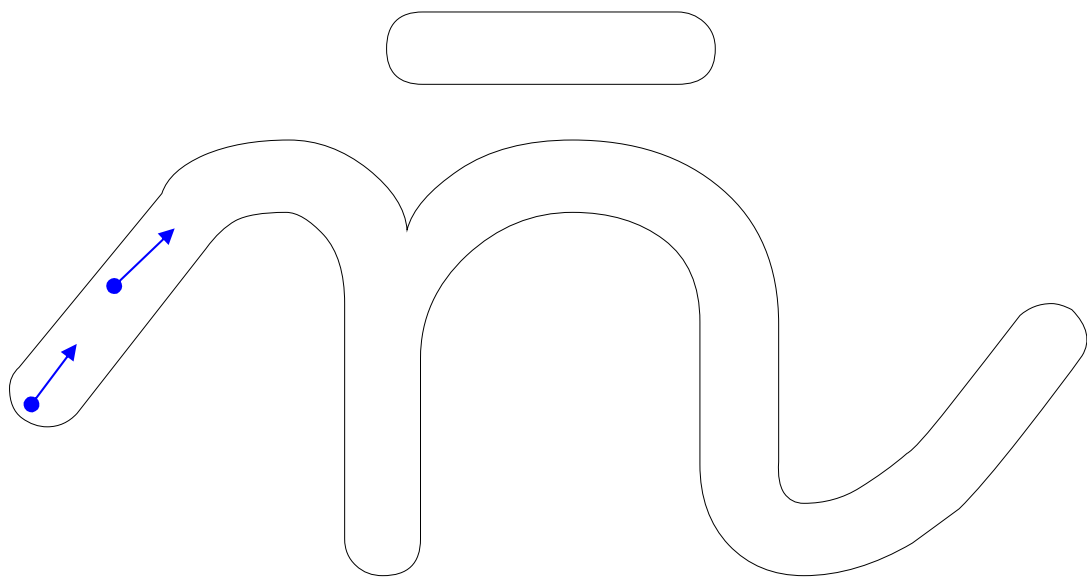

Colorea los dibujos cuyo nombre contenga el fonema "ñ"

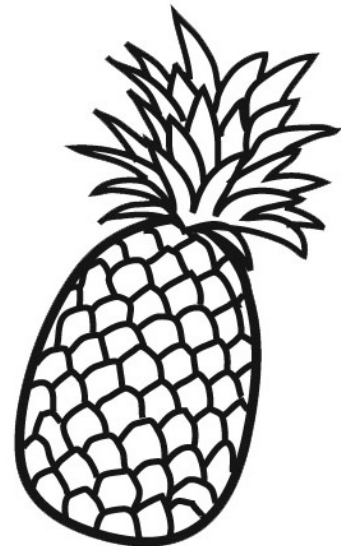
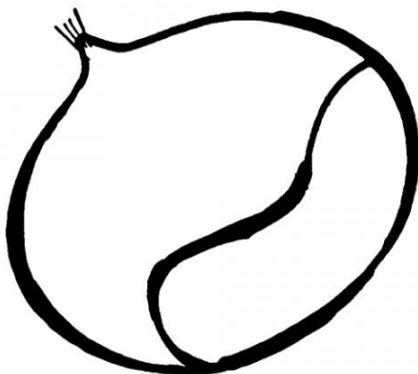
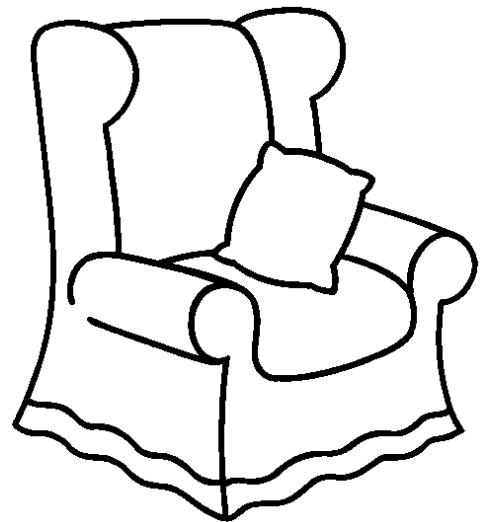
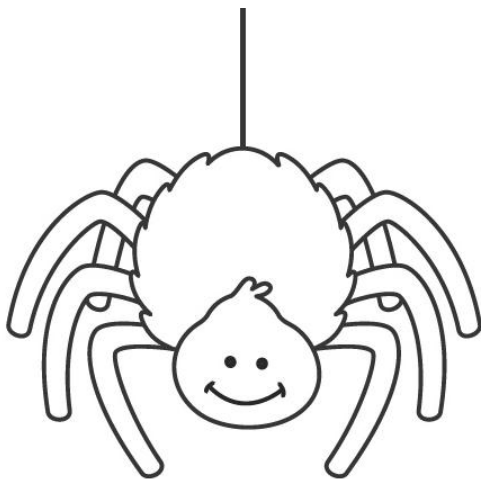
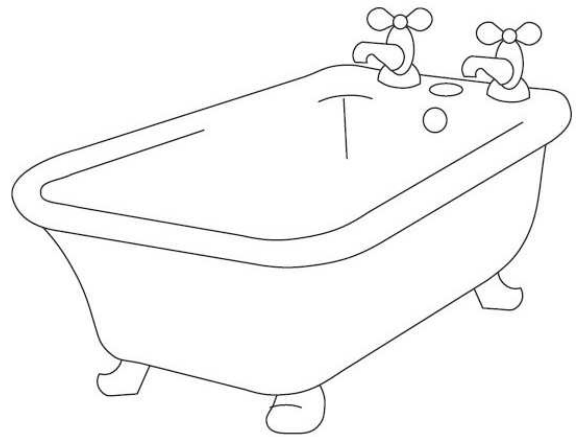

ñ

ñ ñ ñ ñ ñ

ñ

ñ

Ñ

Une las palabras iguales.

piña

peña

uña

dueño

caña

moño

sueño

año

moño

dueño

año

uña

sueño

peña

caña

piña

Une cada dibujo con su nombre.



niño

uña

año

piña

muñeca

peña

moño

moña

puño

pañó

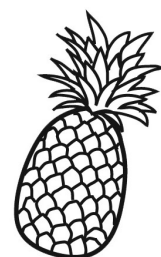

Repasa:

ñ ñ ñ ñ ñ ñ ñ

ñ ñ ñ ñ ñ ñ ñ

Ñ Ñ Ñ Ñ Ñ Ñ Ñ Ñ Ñ Ñ

Ñ Ñ Ñ Ñ Ñ Ñ Ñ Ñ Ñ Ñ

ña ñe ñi ño ñu

ña ñe ñi ño ñu

Repasa:

La niña come niña.

La niña come niña.

Mañana usaré la caña

Mañana usaré la caña

Asa niña y castañas

Asa niña y castañas



jarrón

Pica

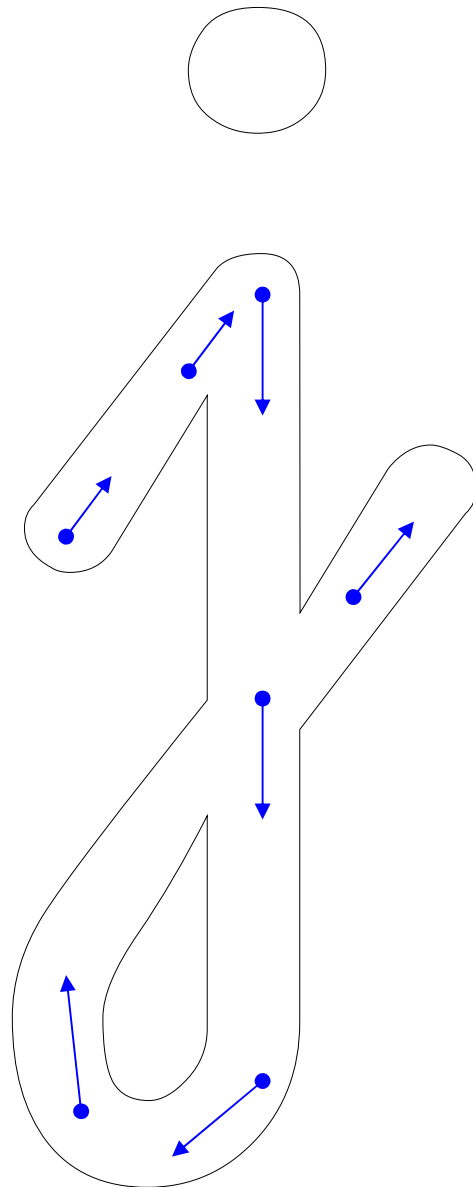

Colorea los dibujos cuyo nombre contenga el fonema "j"

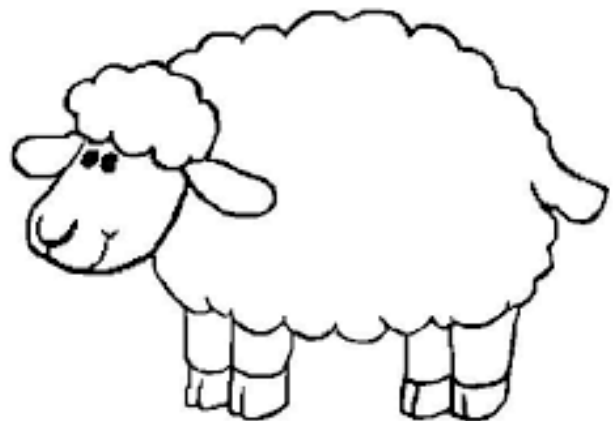
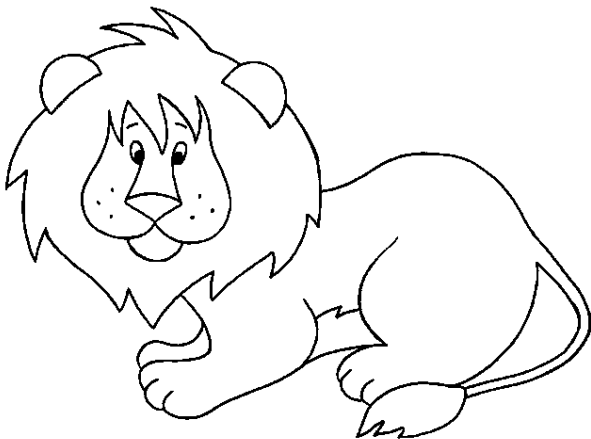
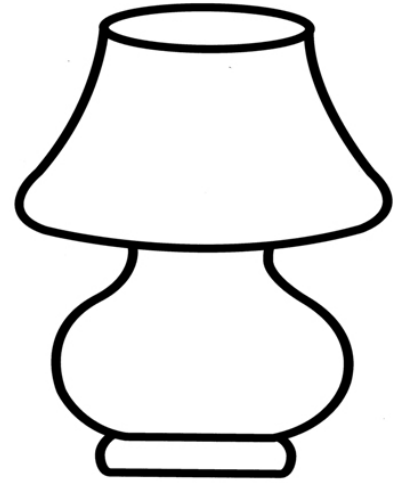
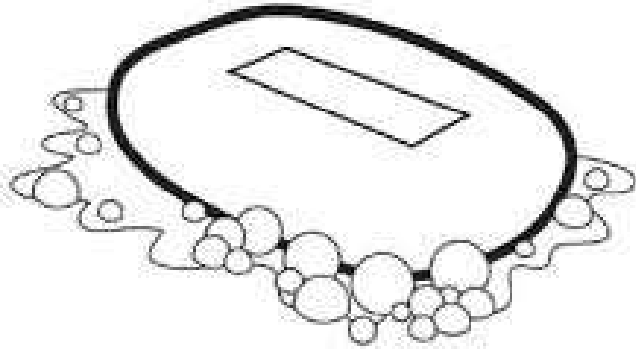

j

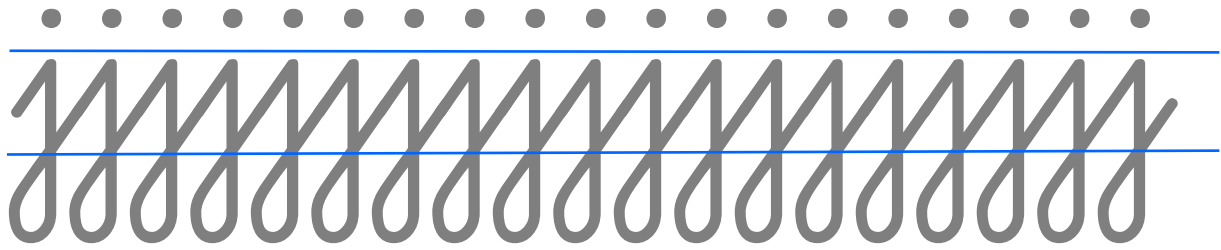

j

j

J

Elijo las palabras adecuadas:

monja

jota

jamón

tajo

ajo

paja

teja

espejo

jeringa

juguetes

jaula

jarabe

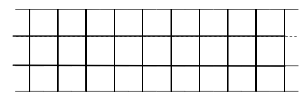
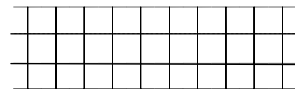
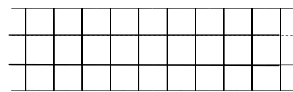
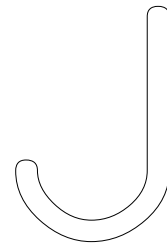
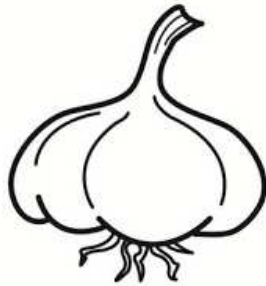
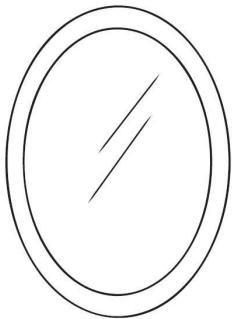

Dibuja y repasa:



Una paja

Una jaula



¿Qué es?

Sirve para colocar flores.

j	a	r	r	ó	n
---	---	---	---	---	---



Sirve para saber la hora.

--	--	--	--	--



Sirve para coser.

--	--	--	--	--

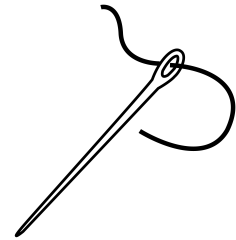

Sirve para mirarse.

--	--	--	--	--	--

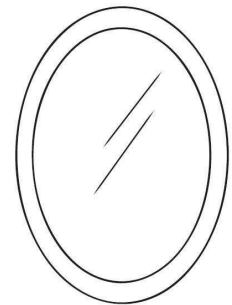

Sirve para cortar.

--	--	--	--	--	--	--

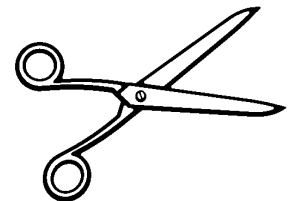

Copia:

j j j j j j j j

j j j j j j j j

u u u u u u u u

u u u u u u u u

ja je ji je ju

Copia:

Ja Je Ji Jo Ju Ja Je

jamién juego jota baja

La jirafa de Juana.

Echa ajo al conejo.

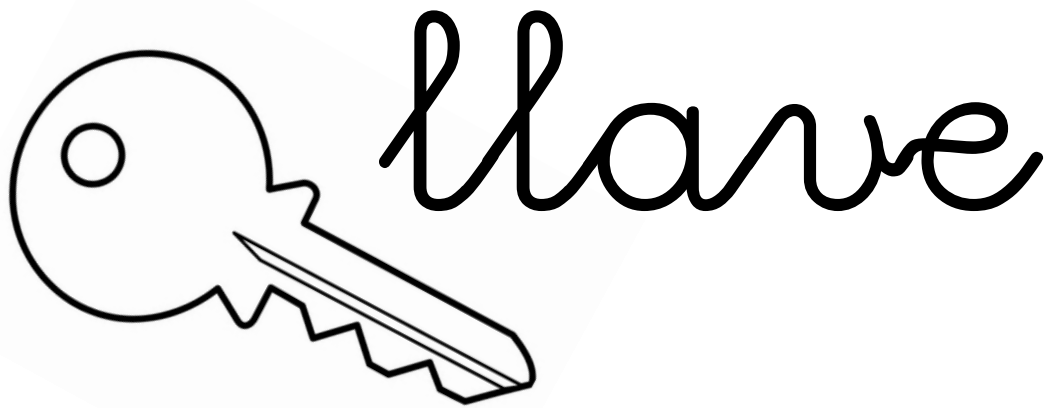

Pica

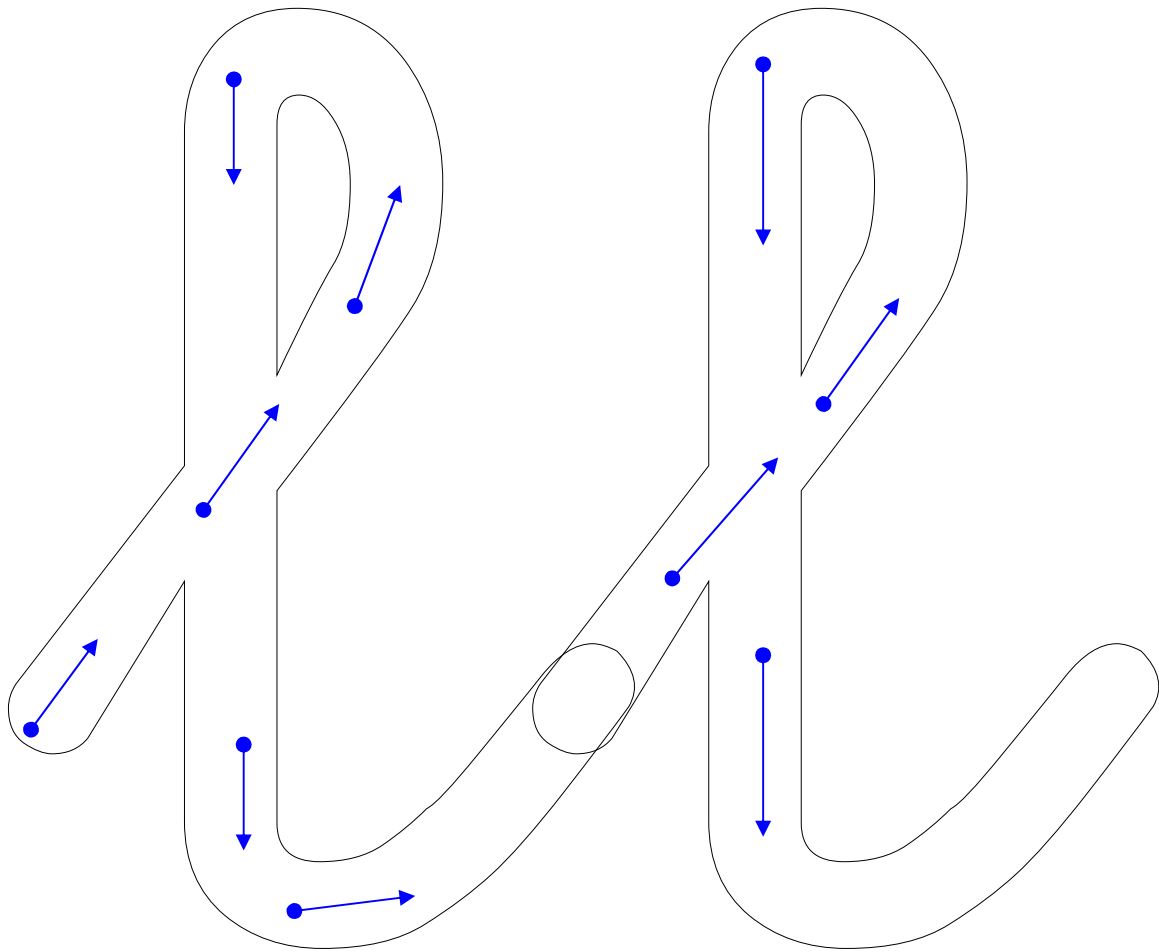

Colorea los dibujos cuyo nombre contenga el fonema "ll"

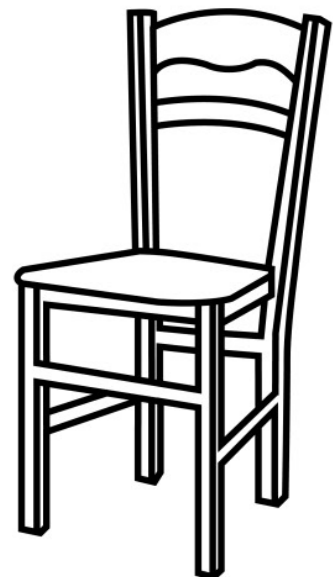
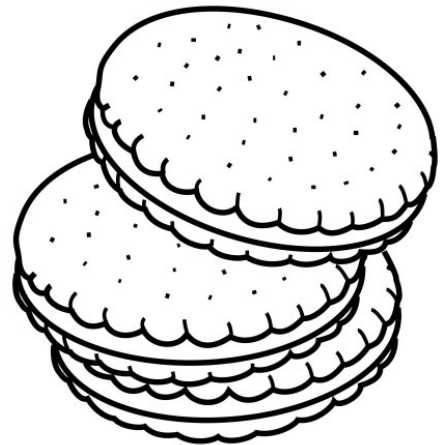
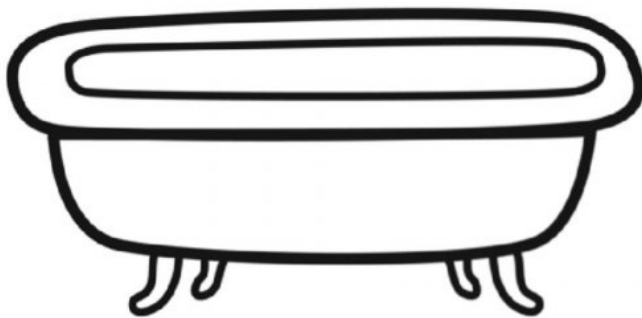
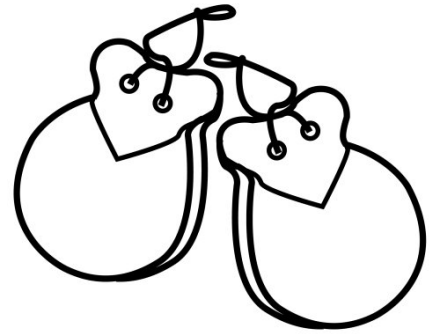

ll

ll ll ll ll

ll

ll

Ll

Completa y dibuja:

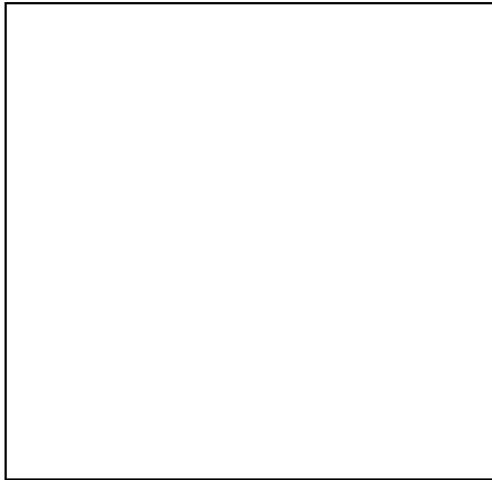

casti _ _ a

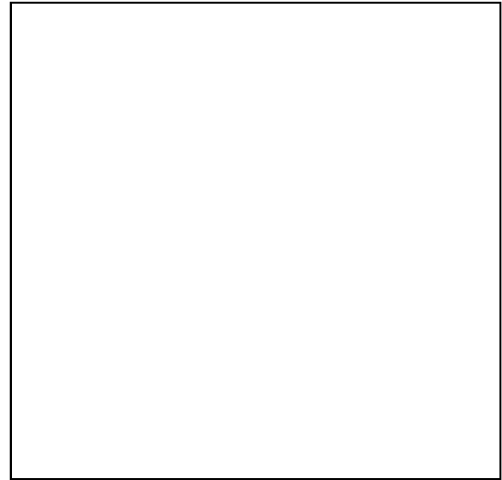

ardi _ _ a

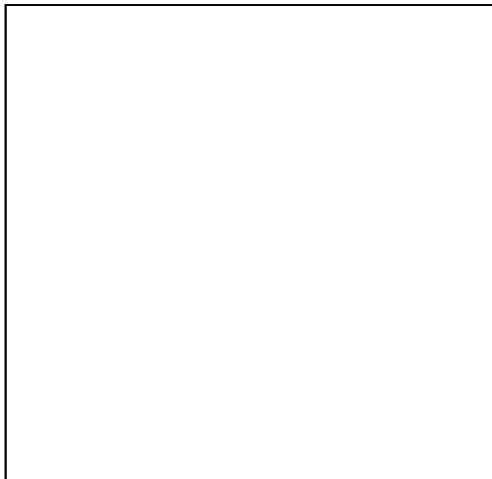

estre _ _ a

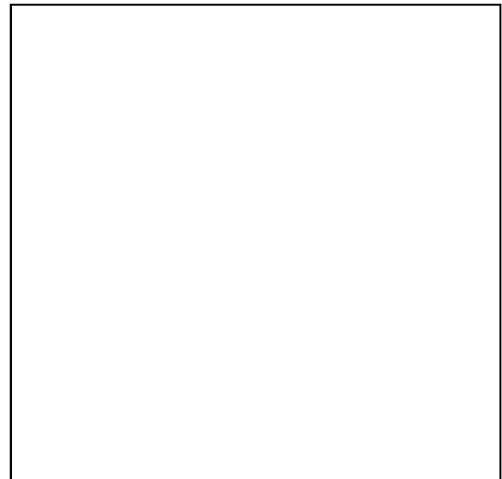

brasi _ _ a

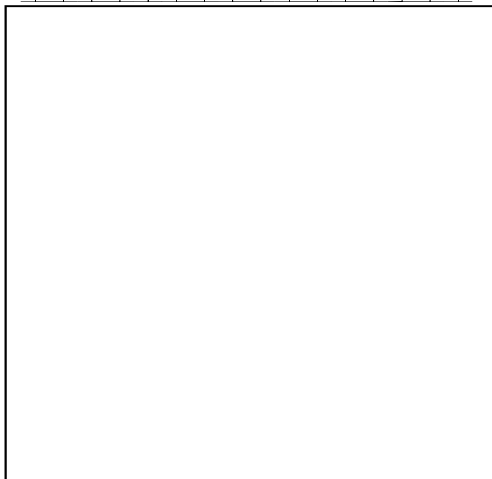

ba _ _ ena

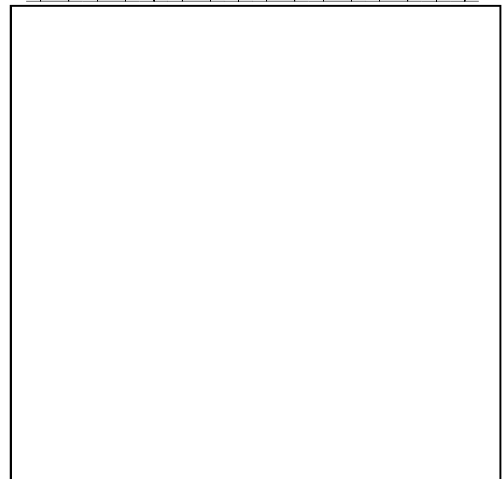

ga _ _ eta

Completa y dibuja:

botella de patatas

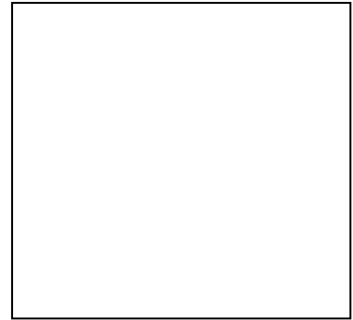

tortilla de leche



llave de mar

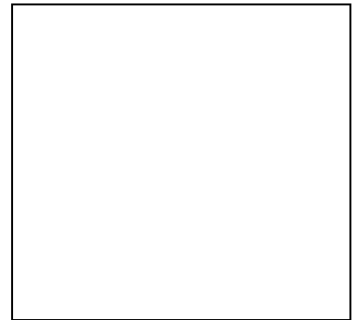

estrella de jamón

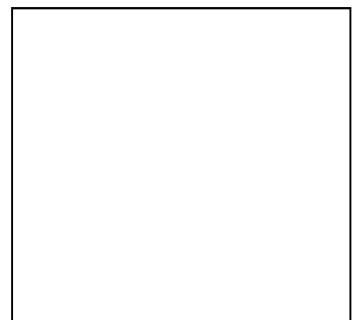

bocadillo del portal

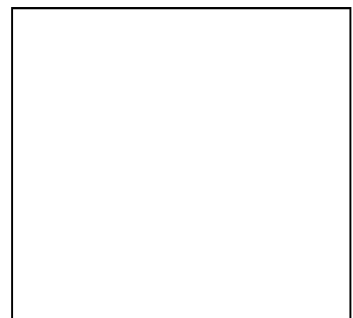

Copia:

lla lle lli llo llu lla

lla lle lli llo llu lla

lla lle lli llo llu lla

llave calle lluvia cuello

Copia:

galle gallina nelle olla

cuchillo cenillo cholla

Una botella amarilla.

za

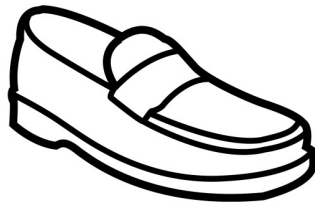

zapato

zo

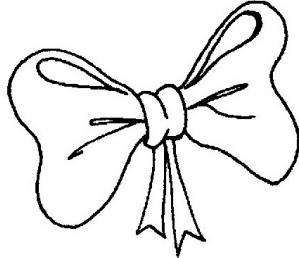

lazo

zu



zueco

Pica

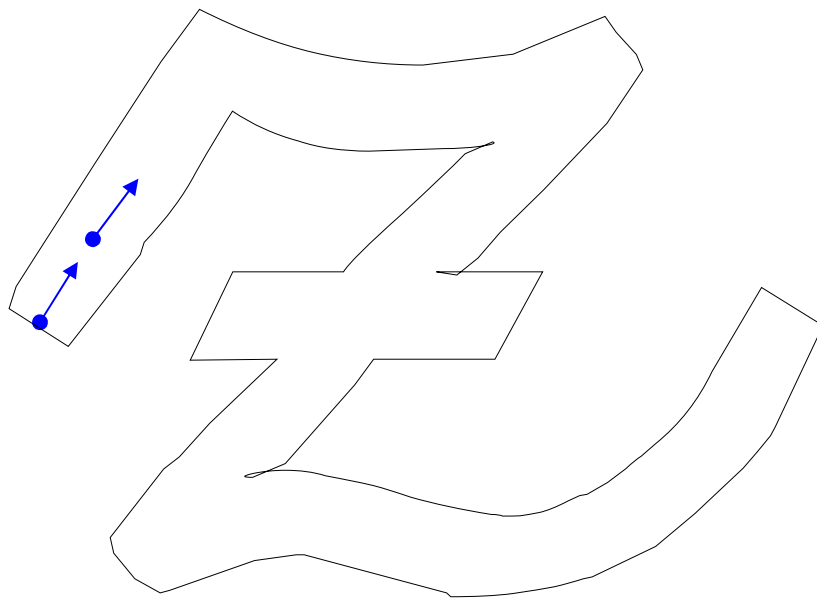

Colorea los dibujos cuyo nombre contenga el fonema "z"

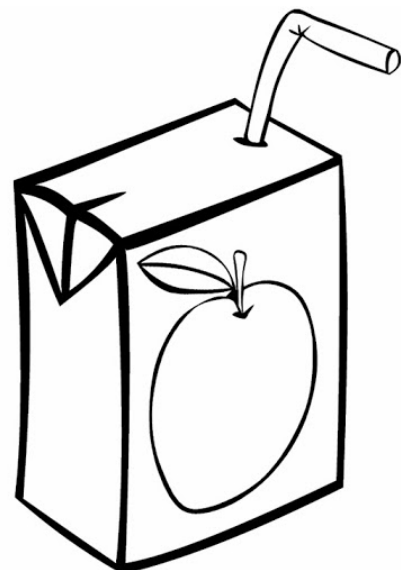
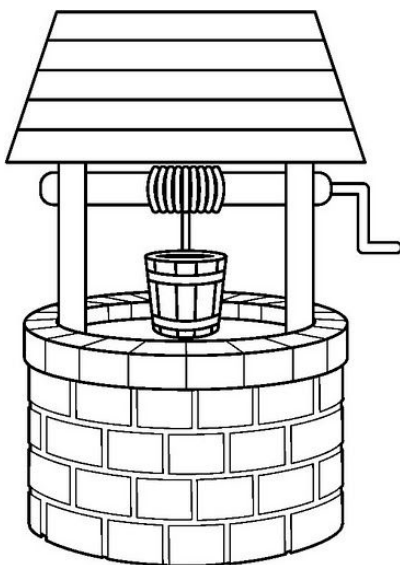
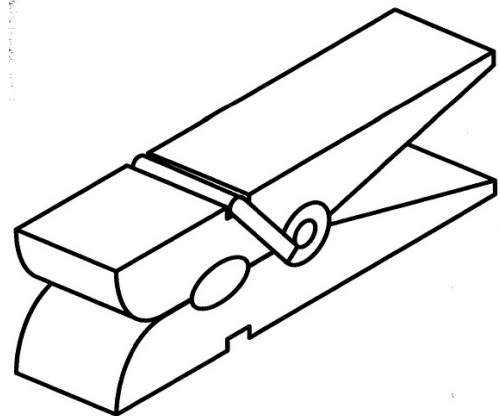
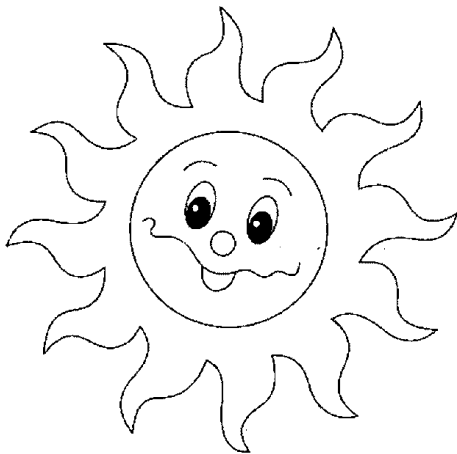

z

z z z z z

z

z

Z

Completa con za-zo-zu:



cora _ _ n

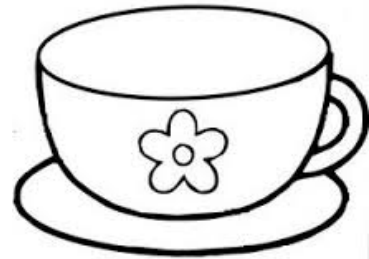

ta _ _

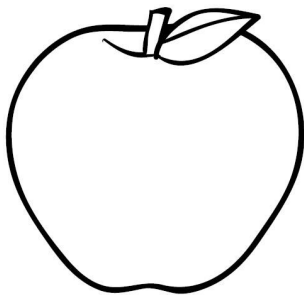

man _ _ na

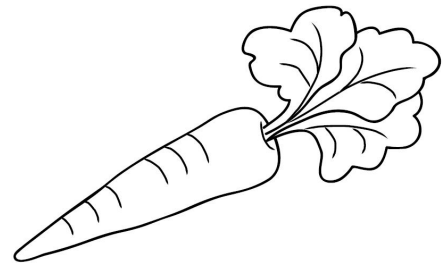

_ _ nahoria

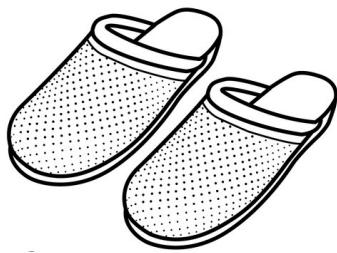

_ _ ecos

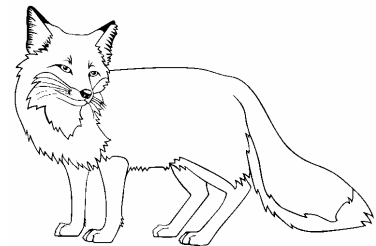

_ _ rro



_ _ nato



ca _ _

Copia:

z z z z z z z z

z z z z z z z z

z z z z z z z z

z z z z z z z z

z z z z z z z z z z z z z

z z z z z z z z z z z z z

z z z z z z z z z z z z z

z z z z z z z z z z z z z

z z z z z z z z

z z z z z z z z

z z z z z z z z

z z z z z z z z

Copia:

La Lo Lu La Lo Lu La

zapato zumo azul oro

Loraida hizo el zumo.

ce

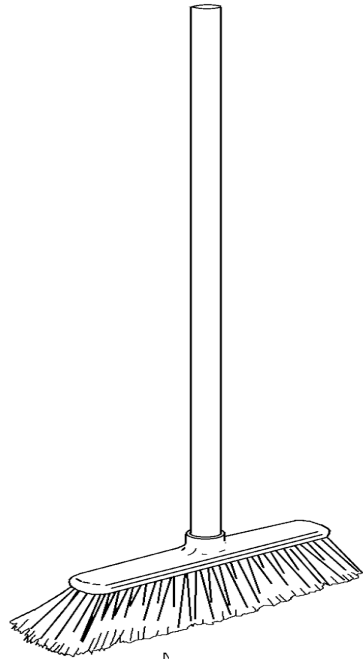

cepillo

ci

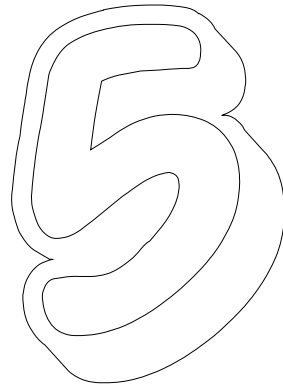

cinco

Colorea los dibujos cuyo nombre contenga los sonidos "ce, ci"

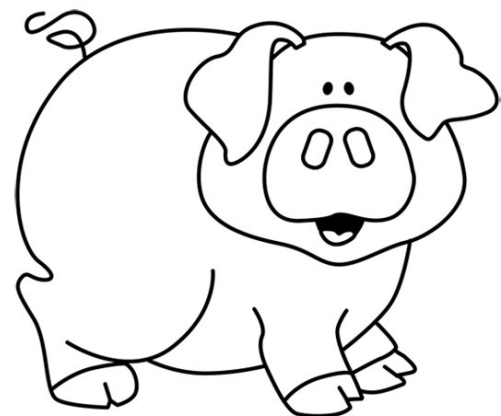
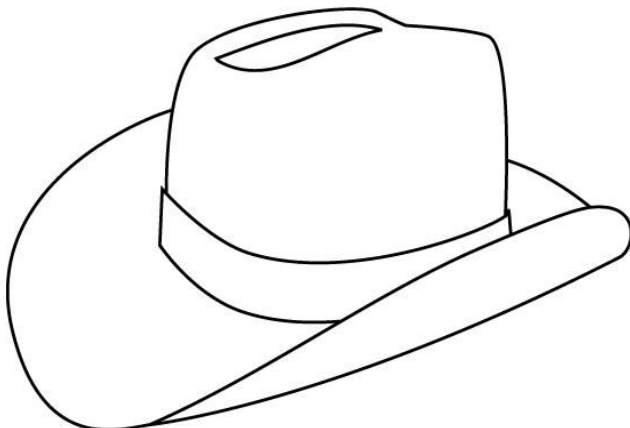
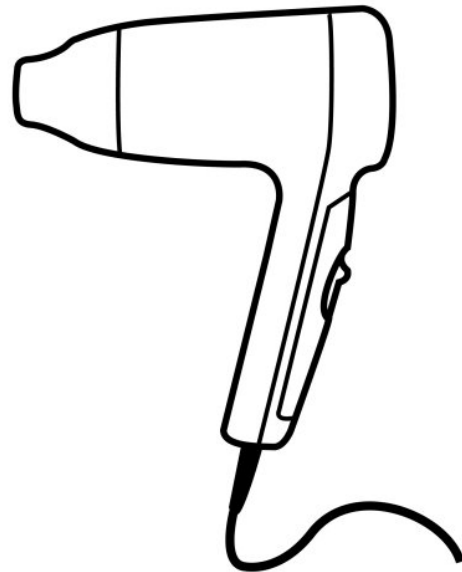
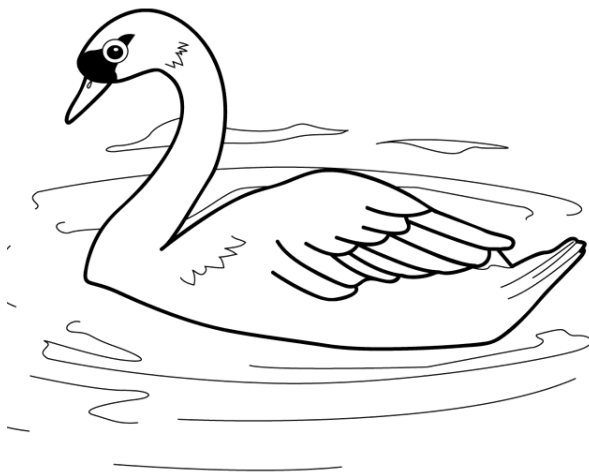
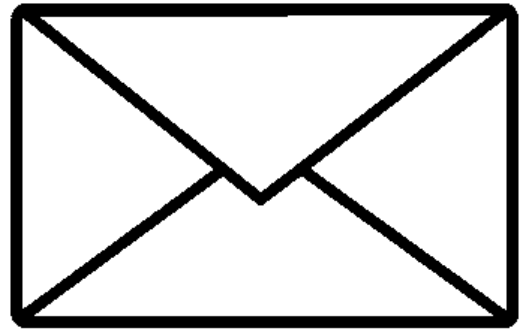
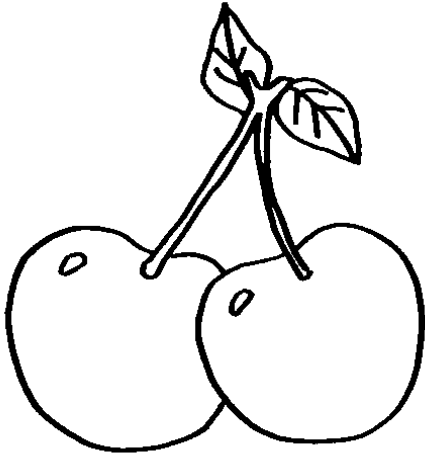

Dibuja y repasa:

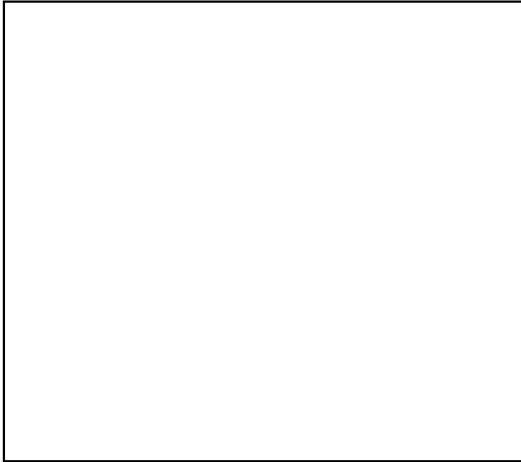

Una maceta

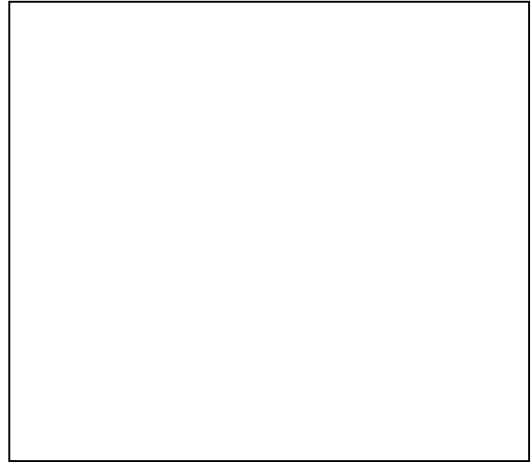

Unos neces



Cinco muñecas

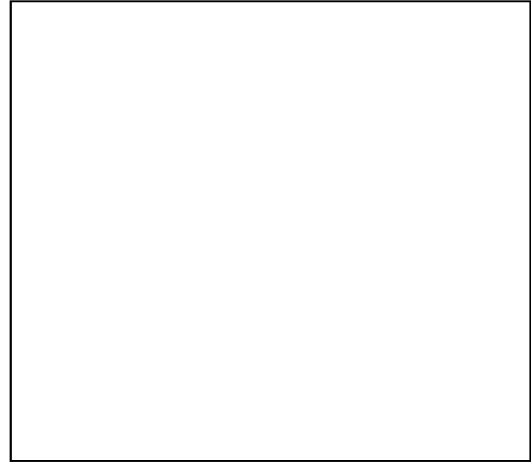

Una niñera



Una cesta



Una necesera

Copia:

ce ci ce ci ce ci

Ce Ci Ce Ci Ce Ci Ce

cera cine acera cena

Copia:

circo cinco cima cita

Cecilia cena ciruelas.

Celia hace una cesta.

gitana



Rodea (ge) (gi)

Toda la gente se reía del gigante Germán.

Todos los días regaba los girasoles y los geranios de su jardín.

Un día, cuando recogía geranios, apareció un genio.

“Me llamo Jorge”, dijo el genio.

“Pide un deseo”.

“Sólo quiero que la gente me quiera aunque yo sea un gigante”, dijo Germán.



Lee y copia:



gemelos

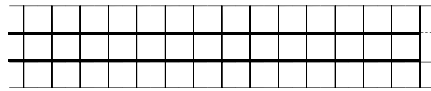

gitana

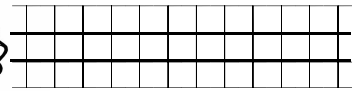

girasol

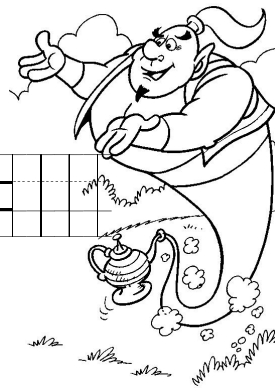
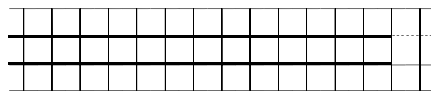

genio

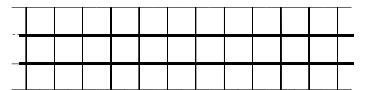

Lee y completa con g:

_erardo es un genio.

Án_ela tiene un bonito

vestido de _itana.

Los _emelos comen

ninas de _irasol.

Clasifica:

mujer gente gemelo jirafa
 gigante página jinete jilguero
 viaje colegio genio jefe

je	ge	ji	gi

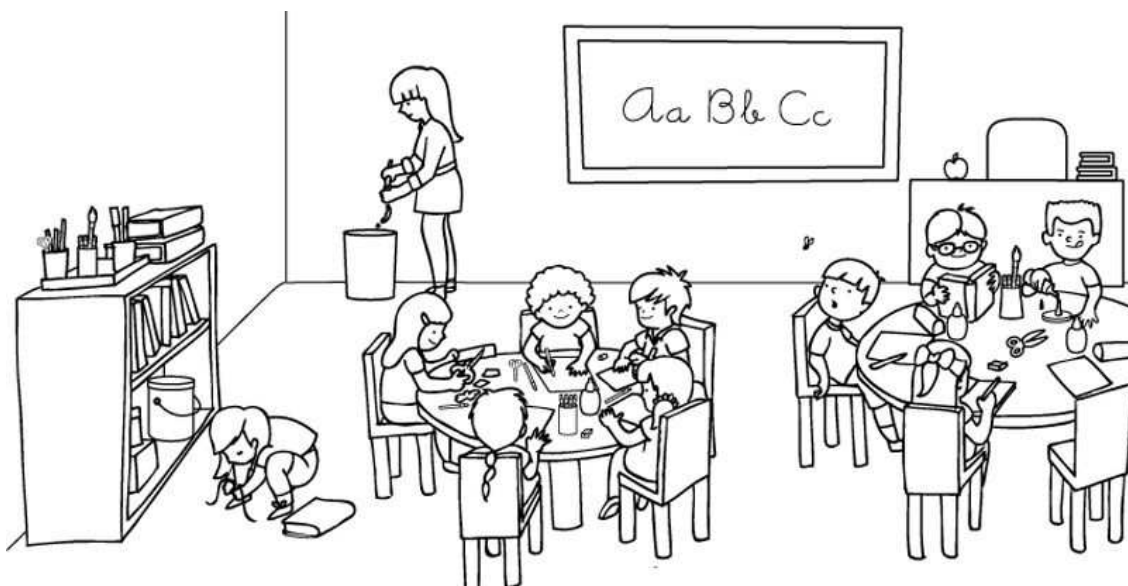

chaqueta



Pica

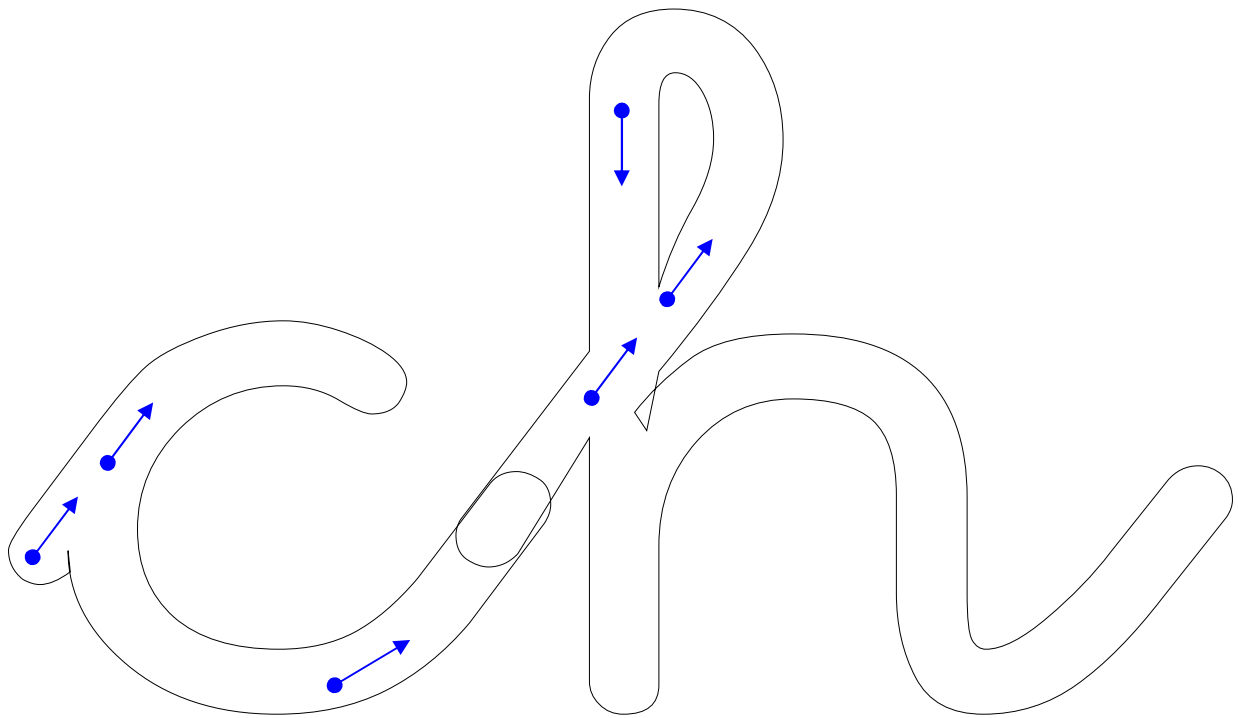

Colorea los dibujos cuyo nombre contenga el fonema "ch"

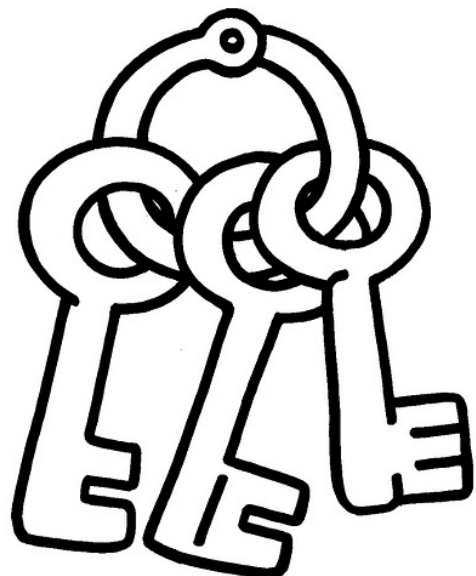
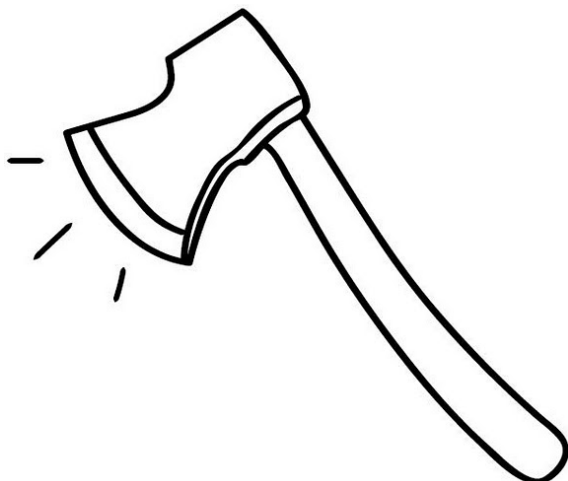
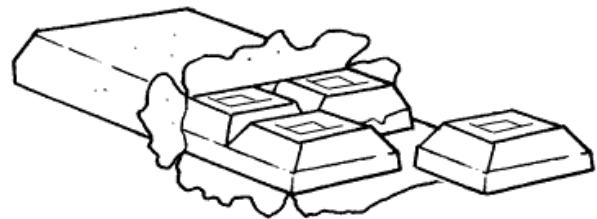
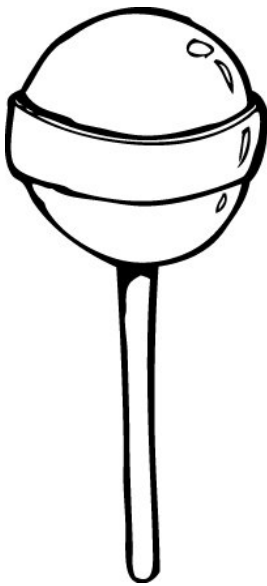
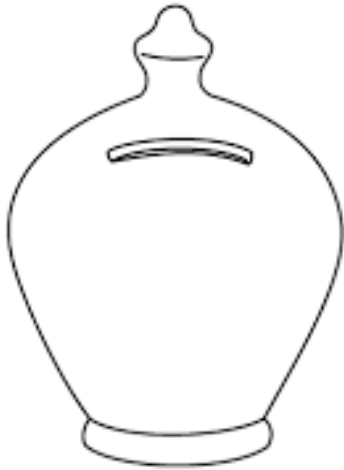

ch

chchchch

ch

ch

Ch

Completa:



Es una chimenea

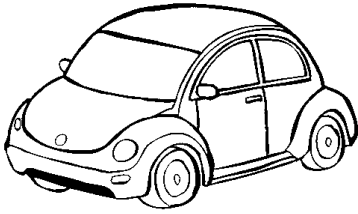

Es un _____.



Es un _____.

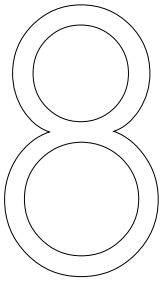

Es un _____.

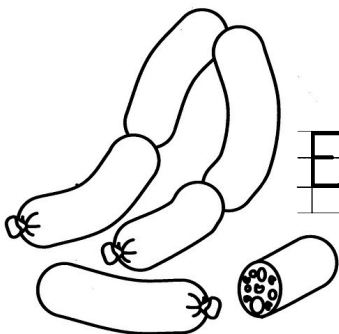

Es un _____.

Copia:

ch ch ch ch ch ch

ch ch ch ch ch ch

Ch Ch Ch Ch Ch Ch Ch

Ch Ch Ch Ch Ch Ch Ch

cha che chi cho chu

Copia:

Cha Che Chi Cho Chu

Cha Che Chi Cho Chu

chico chimenea noche

Chicho come salchichas

Chelo pisa el charco.

taxi



Pica

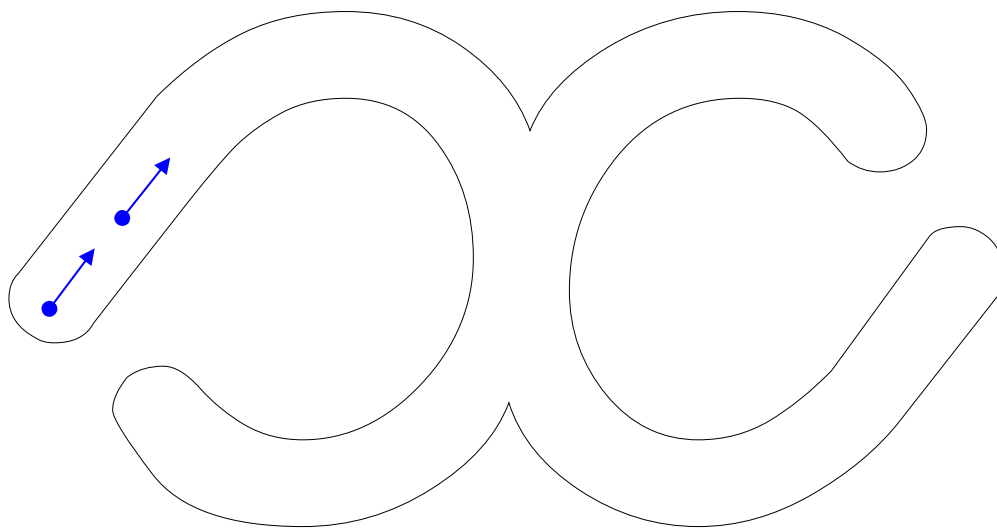

Colorea los dibujos cuyo nombre contenga el fonema "x"

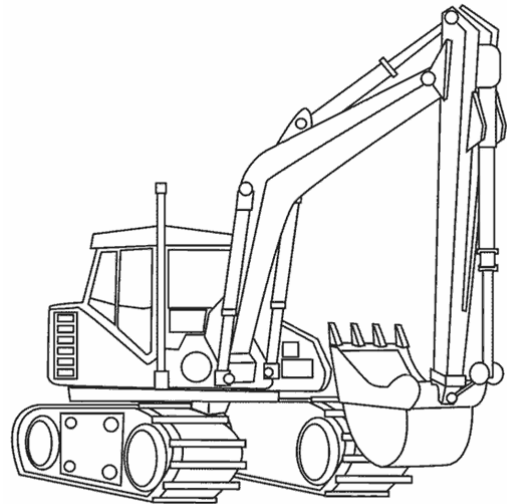
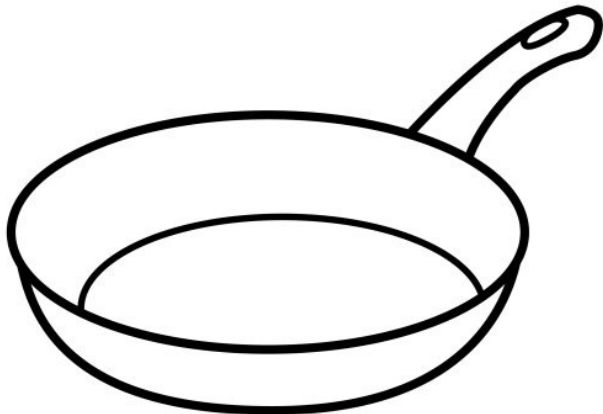
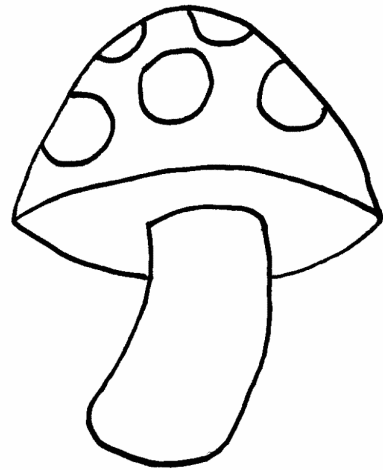
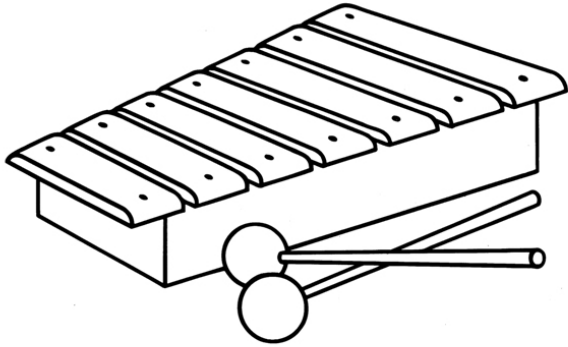

x

x x x x x x x x

x

x

x

Lee y copia:

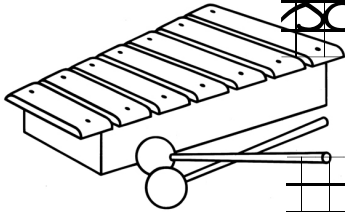

xilófono



saxofón

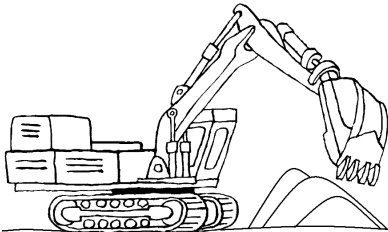

excavadora



taxi

Lee y completa con x:

Después del e_ amen,

los niños de se_ ta,

se fueron de e_ cursión

Copia:

sc sc sc sc sc sc sc

sc sc sc sc sc sc sc

X X X X X X X X X X X X

sca sce sci sce scu

Copia:

Xa Xe Xi Xo Xu Xa Xe

fasci escamen sescto

Máscimo lee un tescto.

kilo

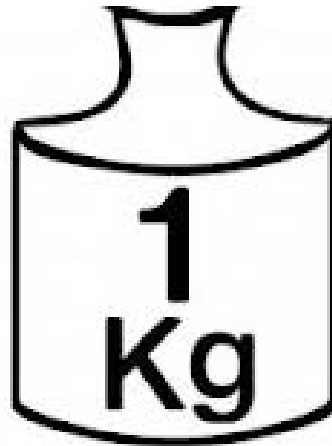

Pica

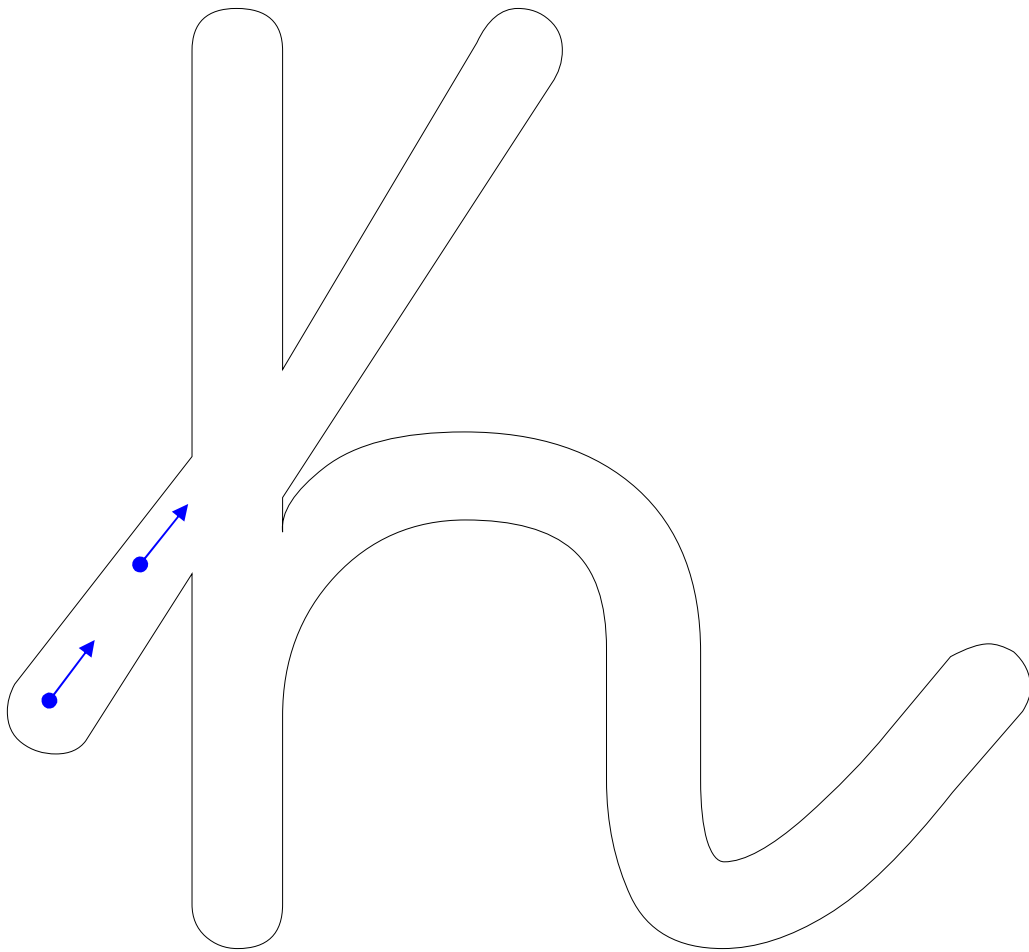

Colorea los dibujos cuyo nombre contenga el fonema "k"

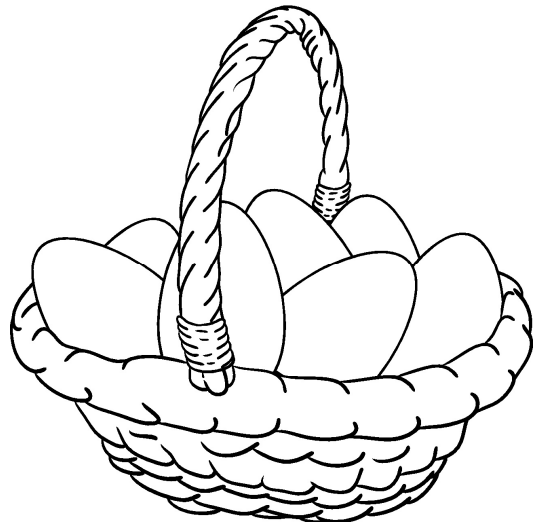
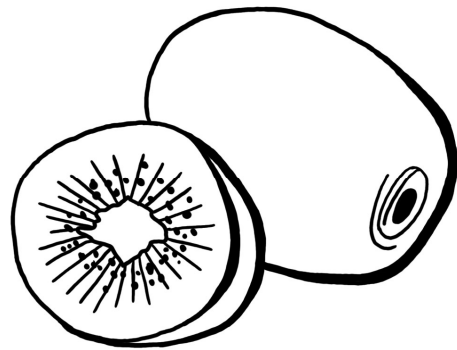
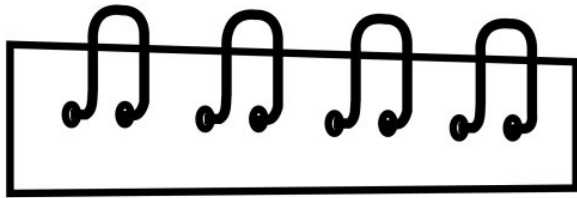
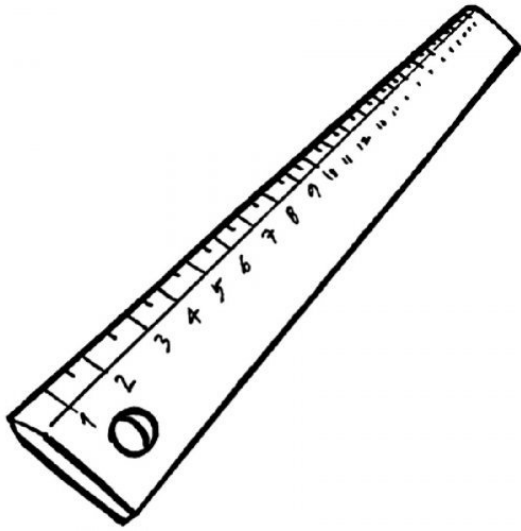

Rodea las palabras que tengan "k".

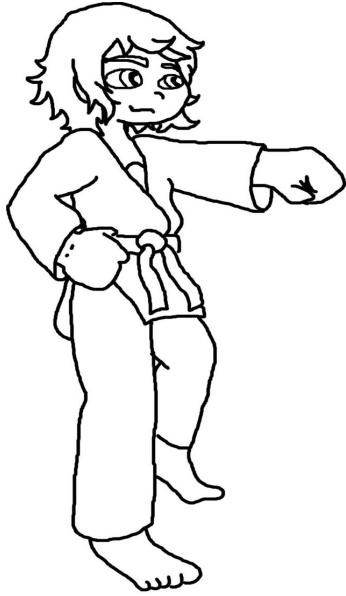

Kati es una gran karateca.

Todos los días, después del colegio, se pone su kimono blanco y va a clase de kárate.

Después, Kati come fruta para merendar. Lo que más le gusta son los kiwis.

Por la noche se acuesta cansada y para dormir bien, se abraza a su koala de peluche preferido, que se lo regaló su hermano Kiko.

Copia:

k k k k k k k k

k k k k k k k k

K K K K K K K K

K K K K K K K K

ka ka ku ka ka ku

Copia:

Ka Ke Ku Ka Ke Ku

Ka Ke Ku Ka Ke Ku

Karate kikos kilo kaki

Kika quiere un koala.

Canta en el karaoke.

windsurf



Pica

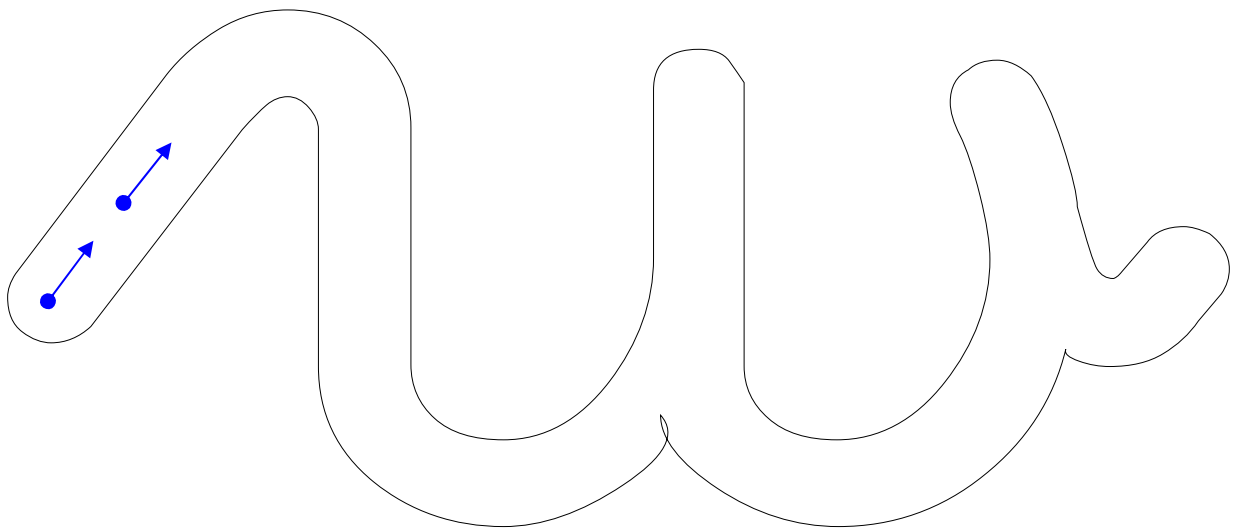

Lee y copia:

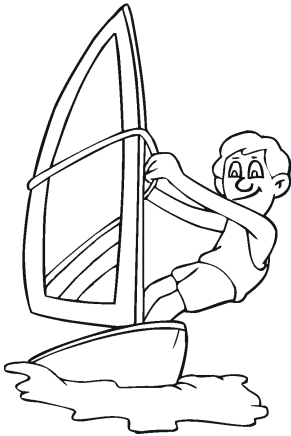

windsurf

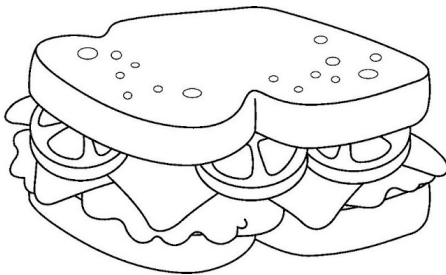
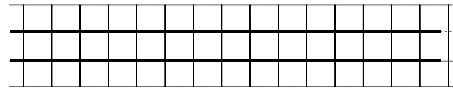

sandwich

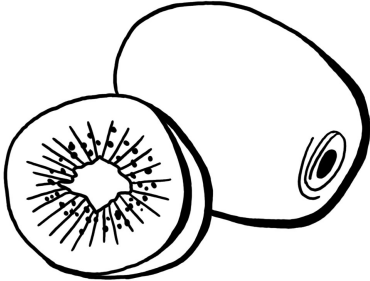
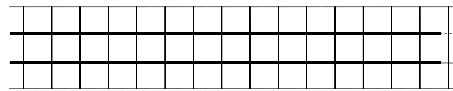

kiwi

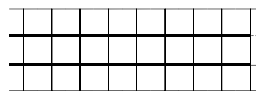

Lee y repasa:

Willy hace windsurf.

Waldo juega muy bien

al waterpolo.

Copia:

ue ue ue ue ue ue ue

ue ue ue ue ue ue ue

W W W W W W W W W

W W W W W W W W W

ua ue ui wo un

Copia:

Wa We Wi Wo Wu Wa

Wa We Wi Wo Wu Wa

Kiwi sandwich uel

Wendy desayuno kiwis.