

Luna

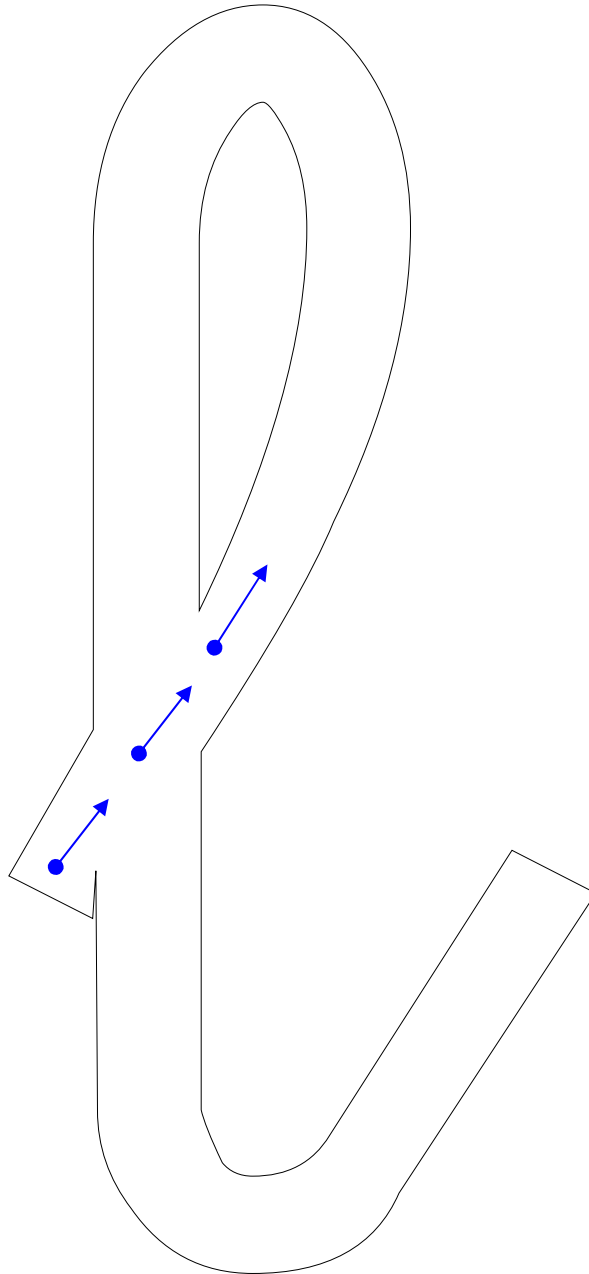

Pica





Colorea los dibujos cuyo nombre contenga el fonema "l"

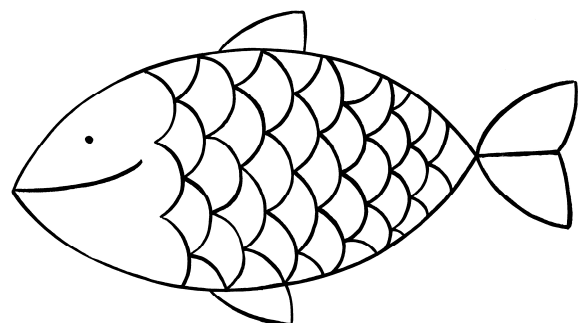
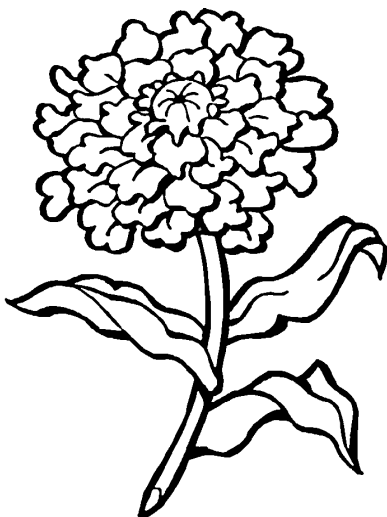
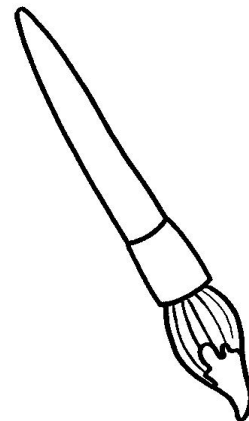
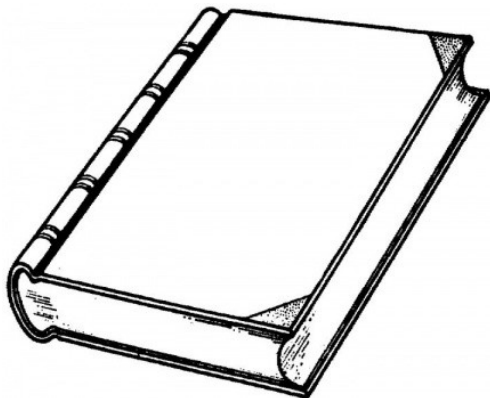
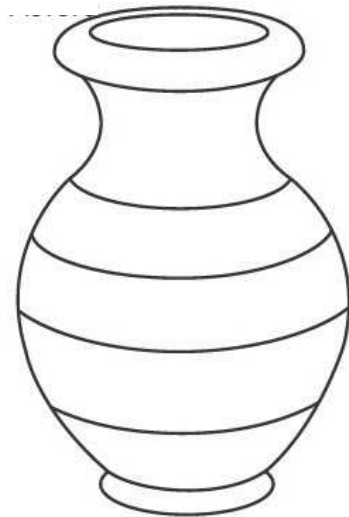
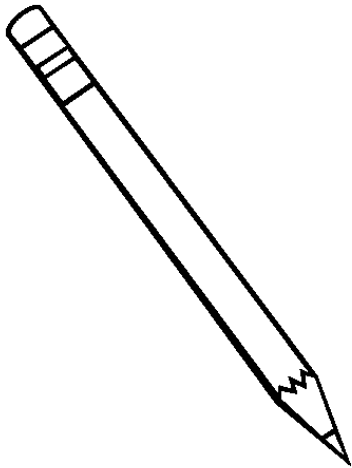



Une con flechas y copia:

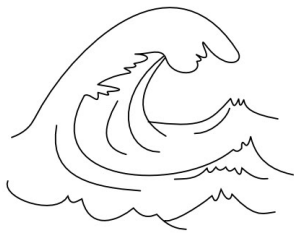

lila

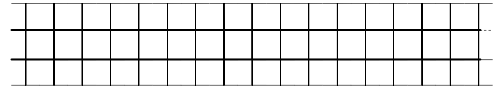

ola

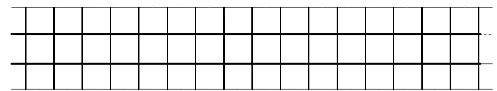

Lili

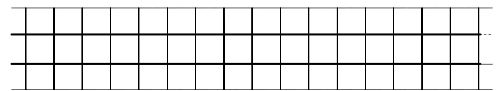

ala

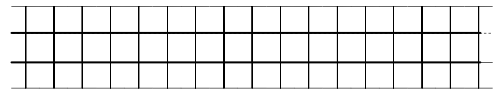

Rodeo la palabra igual:

ala	ola	ala	lía	lila
leía	lía	lila	olía	leía
ola	leo	ola	olía	lio
lelo	lila	leo	lelo	ele
lee	leo	lía	lea	lee

Repasa:

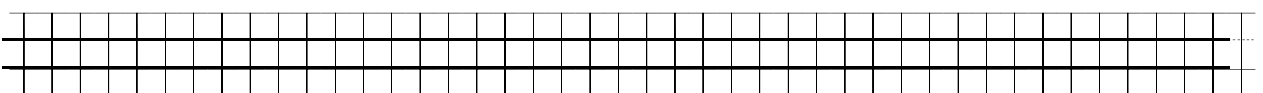
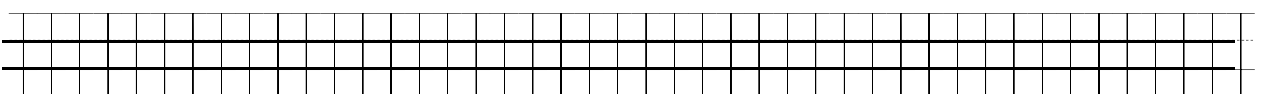
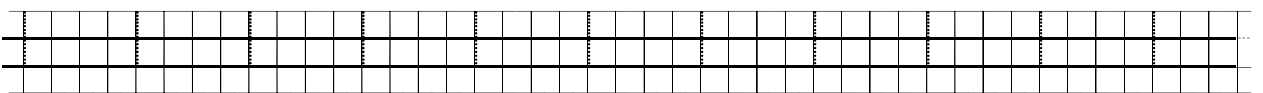
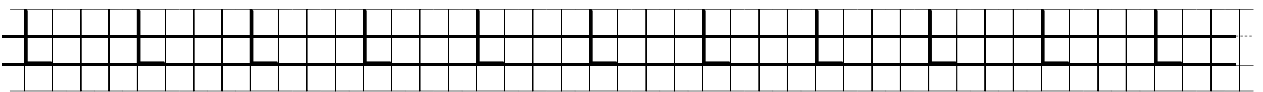
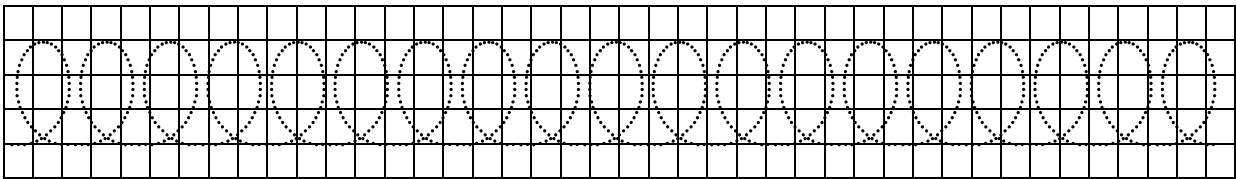
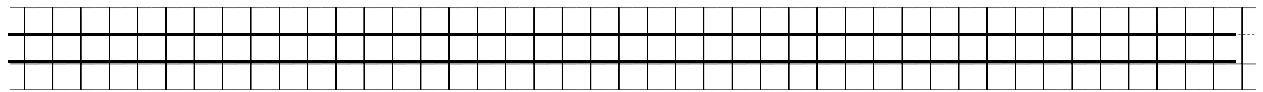
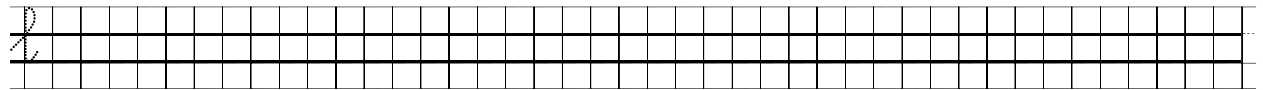
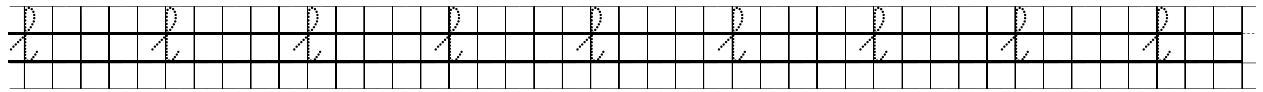
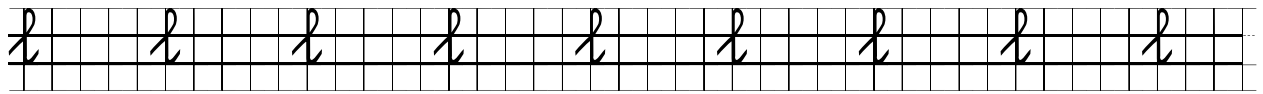



Repasa:

la le li lo lu

la le li lo lu



lampara

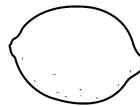

mon



na



lo



ta



lila lana pelo nila

lila lana pelo nila

Repasa:

La Le Li Lo Lu

La Le Li Lo Lu

L l

l f L e L l f e  
 L f L e L L L L  
 l e l L f e l f  
 l l f L l L e L l  
 f L f L l L e l

Lune Leo Lula Lalo

Lune Leo Lula Lalo

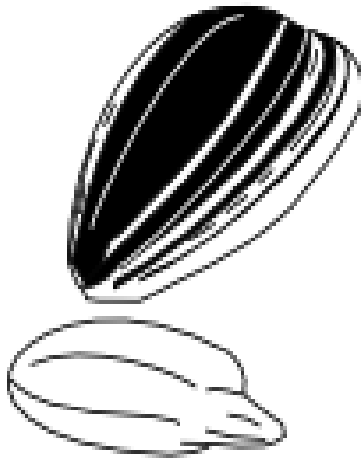

nina



Pica

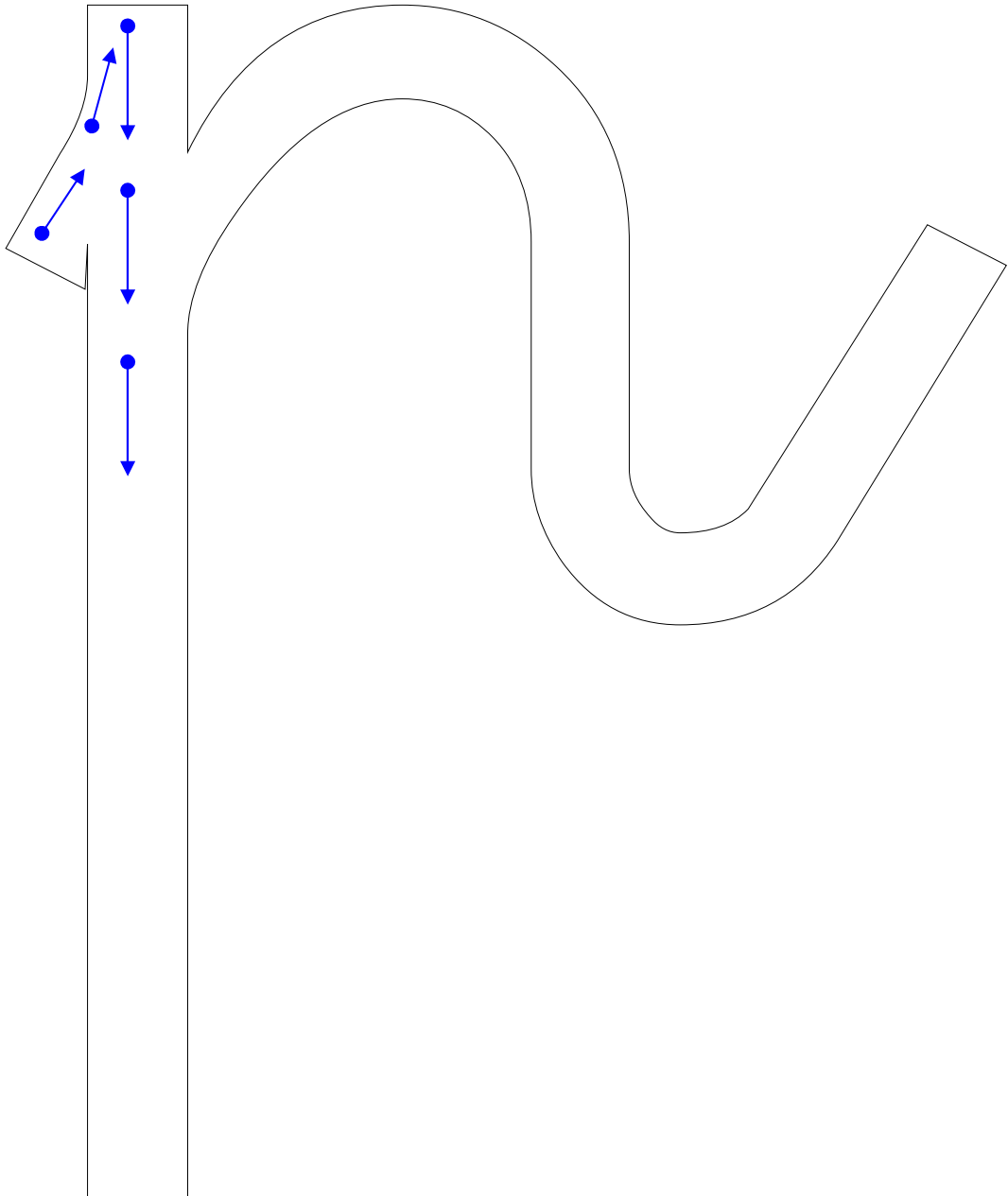



Colorea los dibujos cuyo nombre contenga el fonema "p"

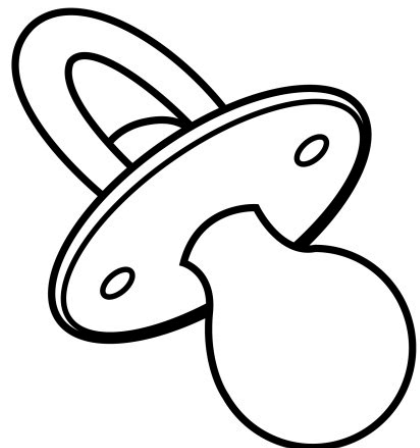
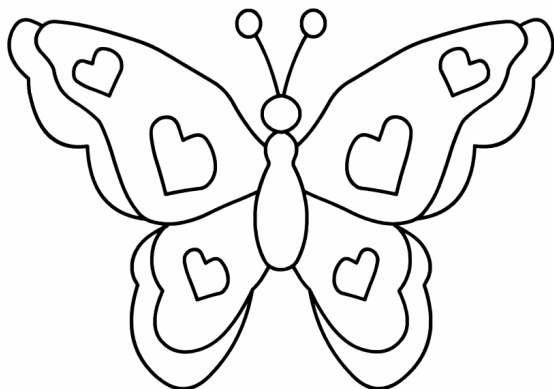
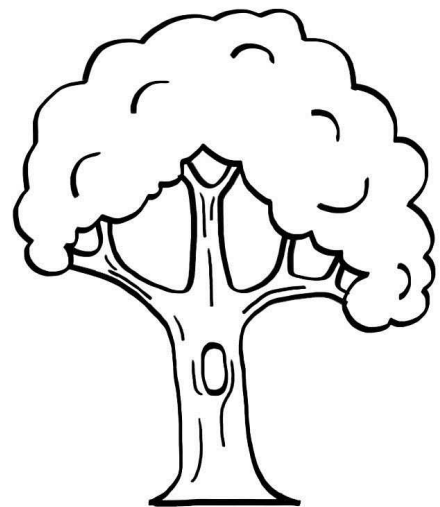
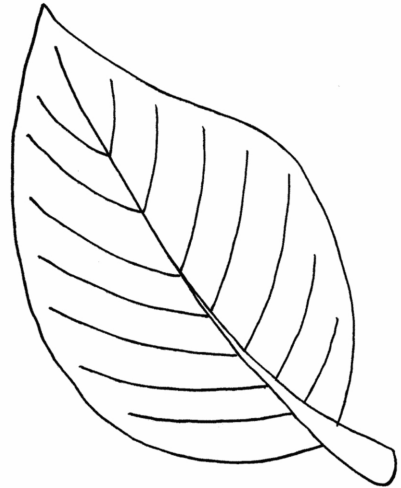
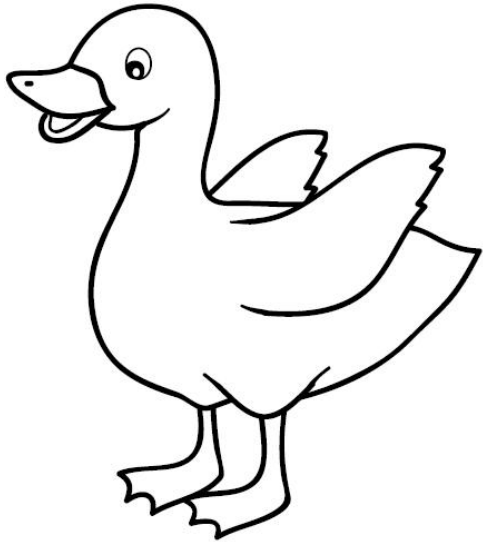

n

n n n n n n n n n n

n

n

P



Une con flechas y copia:



pipa

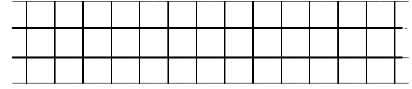

pupa

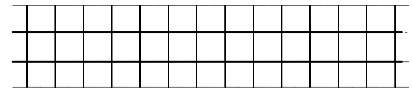

pie

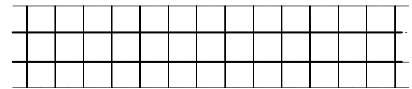

papá

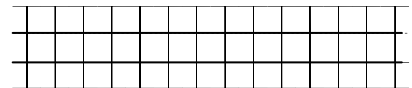

Rodea la palabra igual:

pie	pipa	pie	púa	pupa
pupa	papá	aúpa	pipo	pupa
papá	Pepe	papá	pipa	pupa
Pepe	Pepe	pipa	Pepe	papá
pipo	Púa	pipa	pipo	pio

Repasa:

n n n n n n n

n n n n n n n

n

n n n n

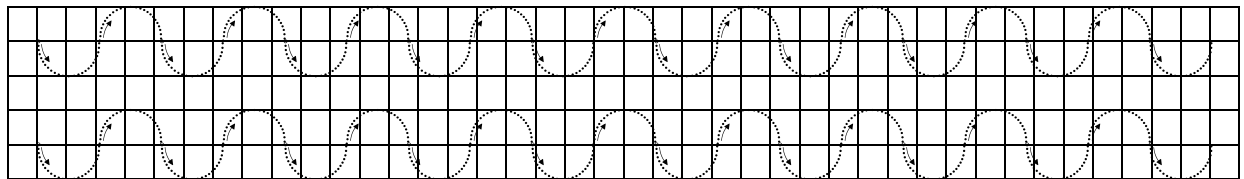

P P P P

P P P P P P P P P P

P P P P P P P P P P

P

Repasa:

na ne ni no nu

na ne ni no nu



nana nita nuna nie

nala papel pulpa rio

Repasa:

Pa Pe Pi Po Pu

Pa Pe Pi Po Pu

Une:

pa pe pi po pu

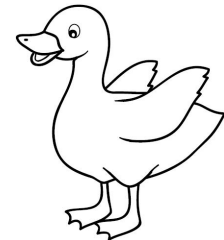
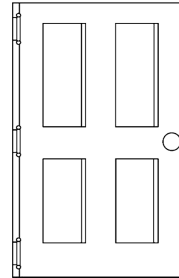
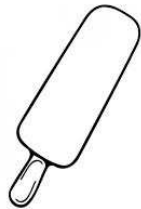

Pena Pene Pili Pío

Pena Pene Pili Pío

mano

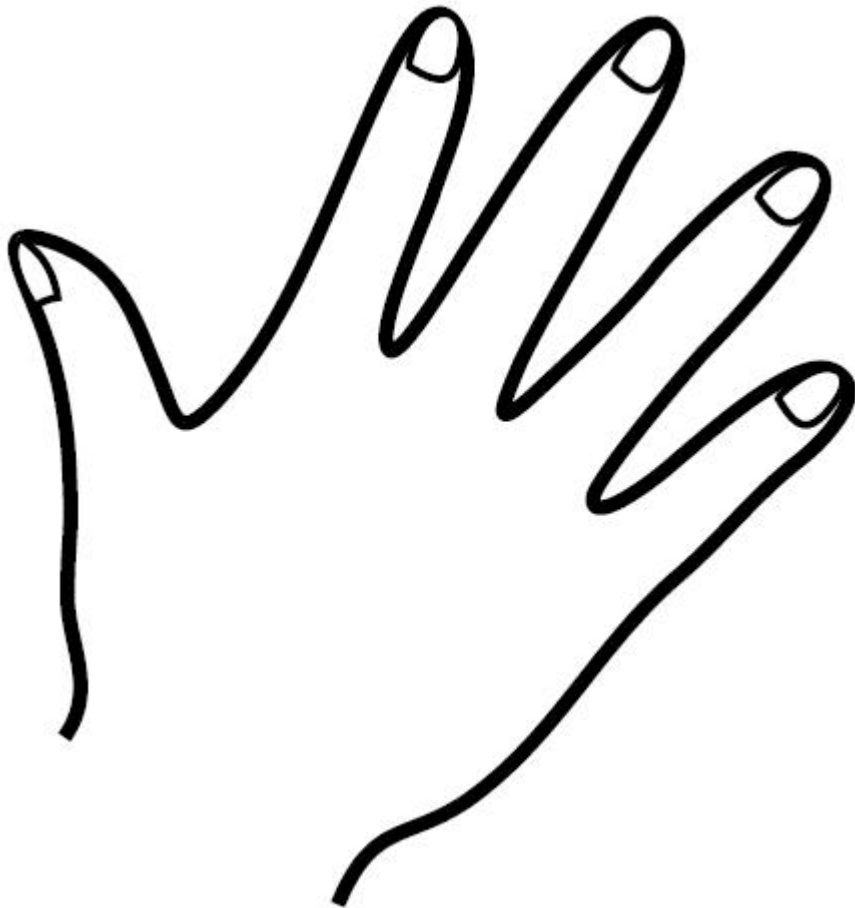



Pica

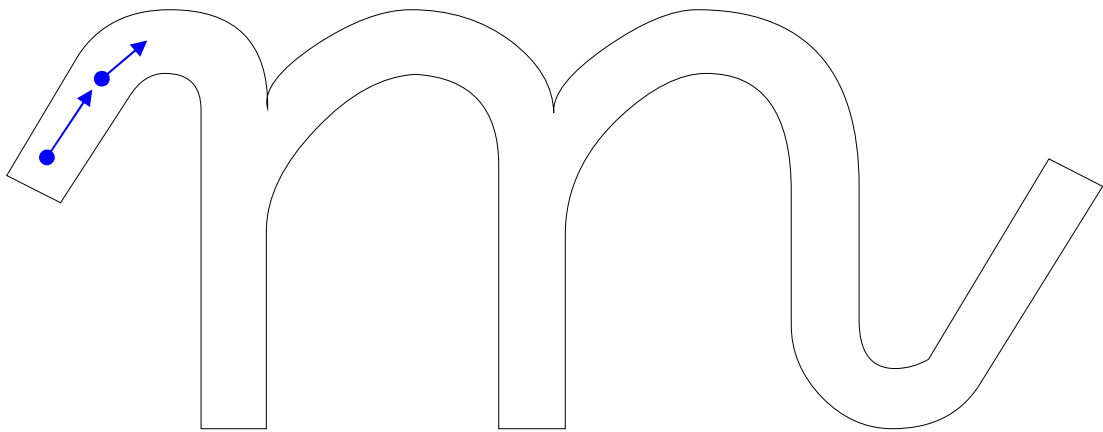





Colorea los dibujos cuyo nombre contenga el fonema "m"

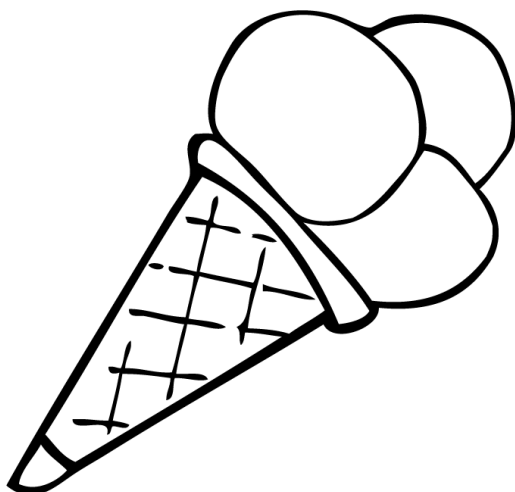
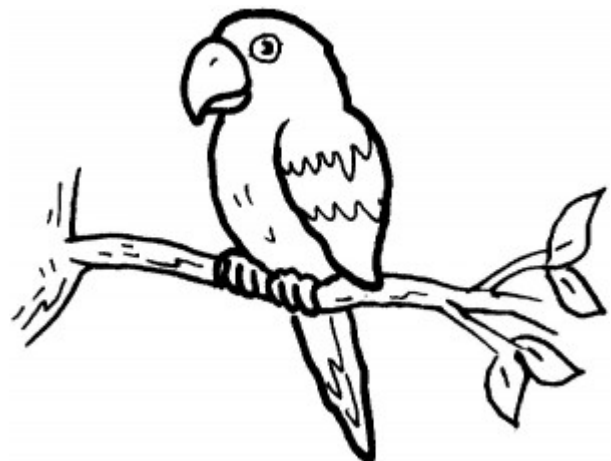
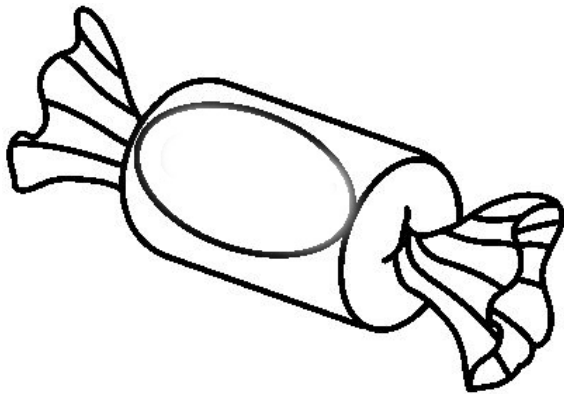
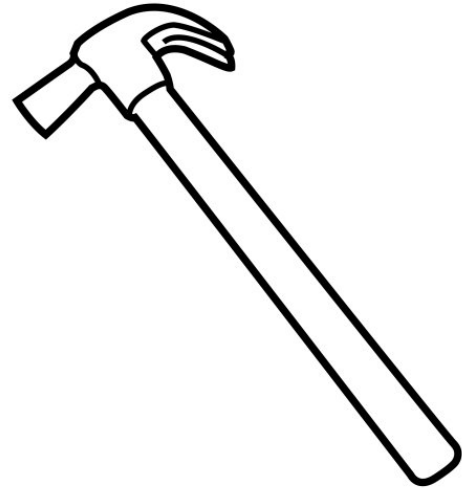
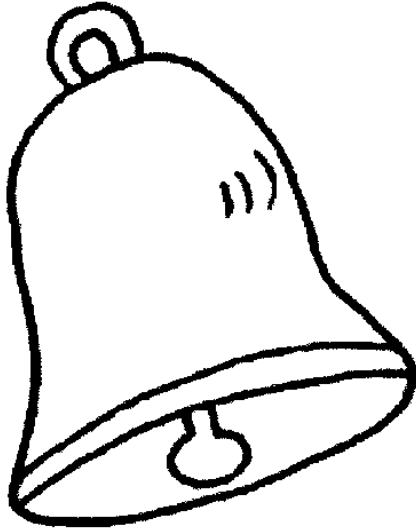

m

m m m m m m m m

m

m

M

Rodea la palabra igual:

mapa	puma	mamá	mapa	mío
Mimí	miau	mimo	mío	Mimí
mamá	mapa	mamá	pomo	puma
pomo	amo	puma	mimo	pomo
mima	mema	mimo	mima	mío

Completa con:

me

mi

mo

mu

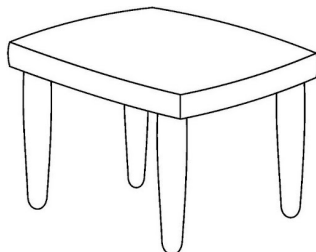
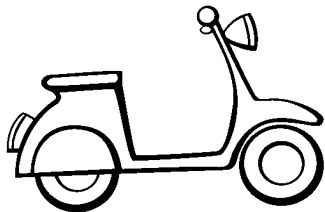

meta

sa

ñeca

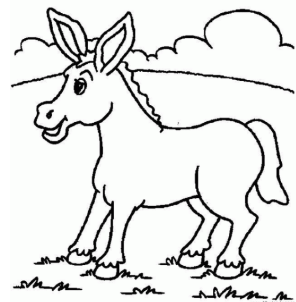
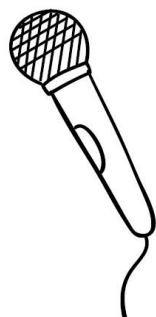

crofano

la

Repasa:

m m m m m m

m m m m m m

m

m m m m m m m m

m m m m m m

M M M M M M M M

M M M M M M M M

M

Repasa:

ma me mi mo mu

ma me mi mo mu

am em im om um

am em im om um

mapa mula Mila mil

mapa mula Mila mil

Repasa:

El mana de mamá

El mana de mamá

Dibuja

Mila lame el nabo.

Mila lame el nabo.

Dibuja

sol







Pica

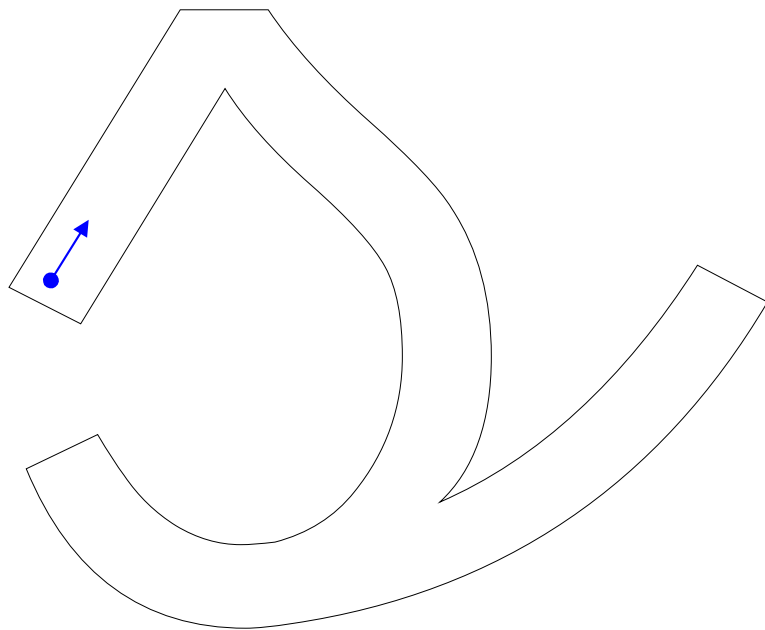



Colorea los dibujos cuyo nombre contenga el fonema "s"

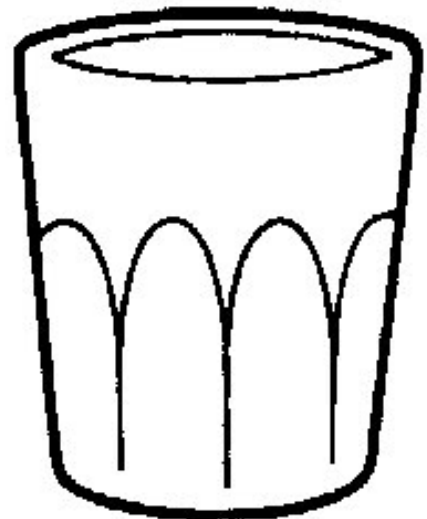
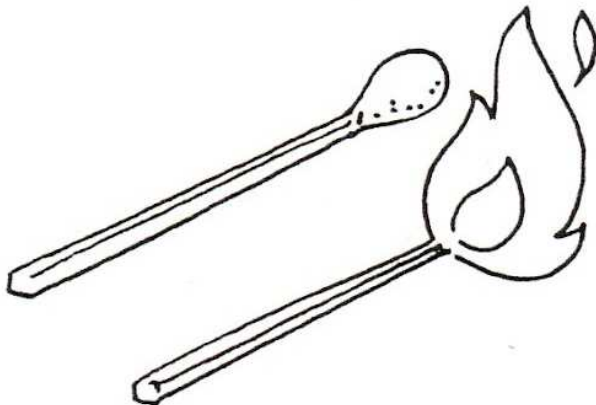
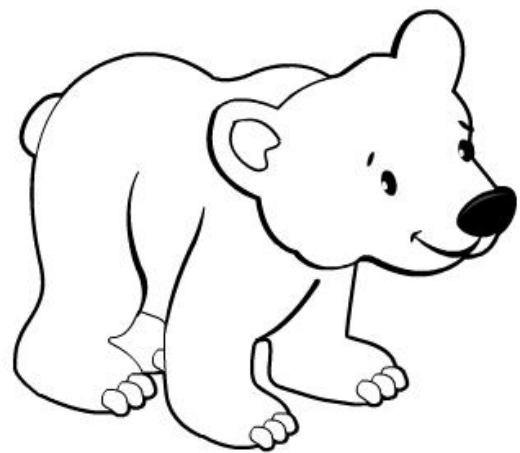
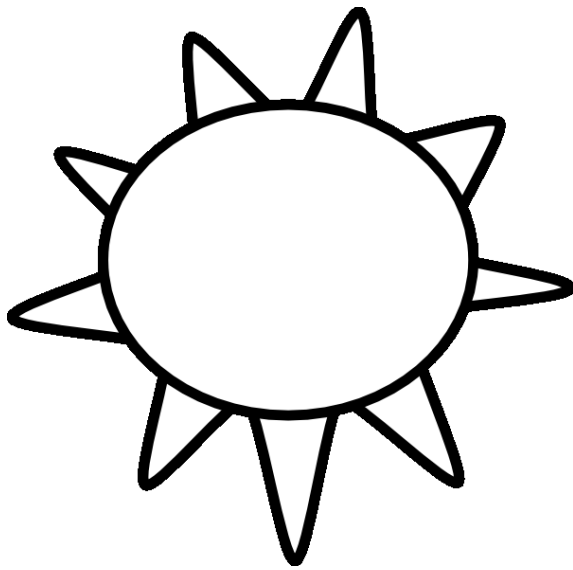
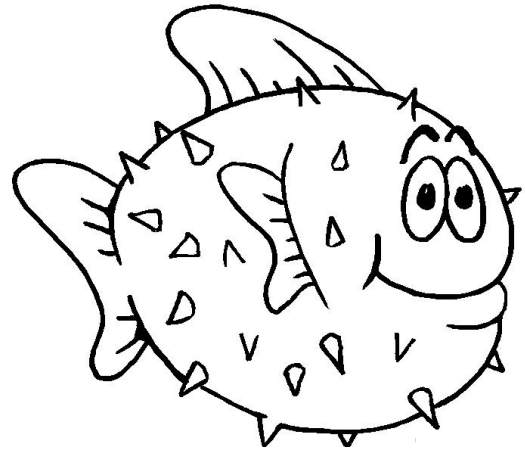

2



2

2

S

Une con flechas y copia:

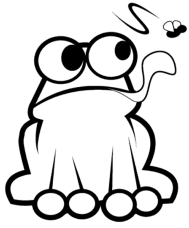

seta

$$\begin{array}{r} 1 \\ +2 \\ \hline 3 \end{array}$$

sapo

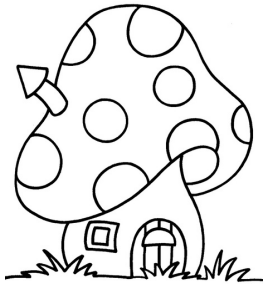
suma



sal

seis

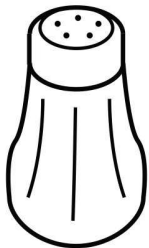
6

sopa

Rodea la palabra igual:

sapo	paso	sopa	peso	sapo
piso	puso	paso	piso	peso
lisa	sol	lisa	Luis	sal
mesa	misa	mamá	mesa	masa
mamá	mema	mima	mamá	mal

Elige la palabra adecuada:

sol

oso

peso

isla

sapo

mesa

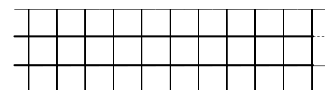
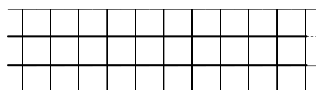
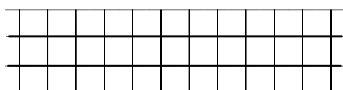
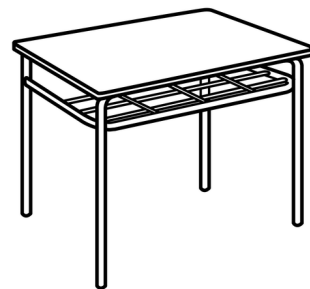
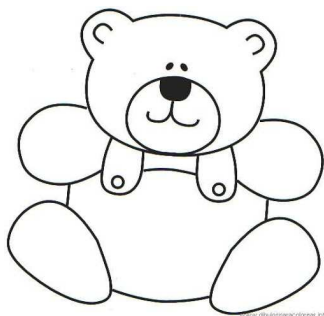
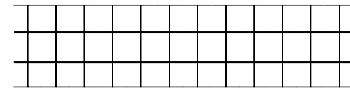
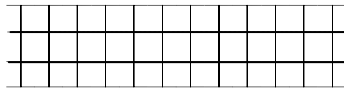
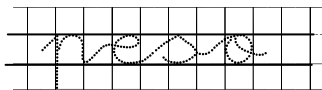
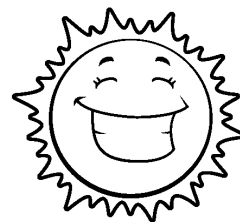

Repasa:

s s s s s s s

s s s s s s s

S S S S S S S

S S S S S S S

sa se si se su

sa se si se su

Repasa:

os es is os us

os es is os us

sano suma mesa

Susi sale al sol.

Susi sale al sol.

Dibuja



taza





Pica

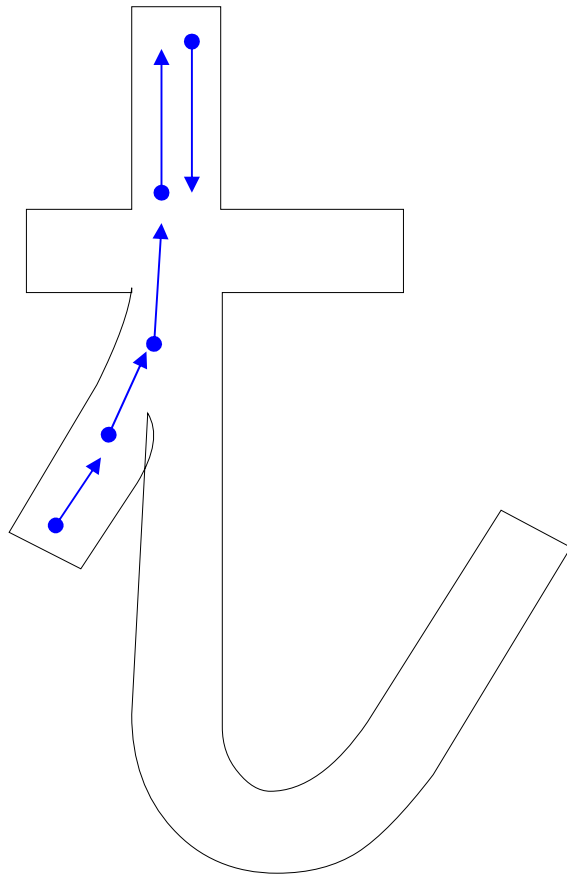



Colorea los dibujos cuyo nombre contenga el fonema "t"

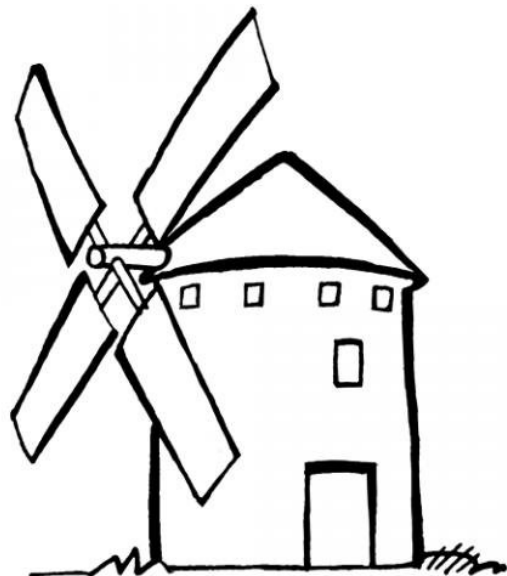
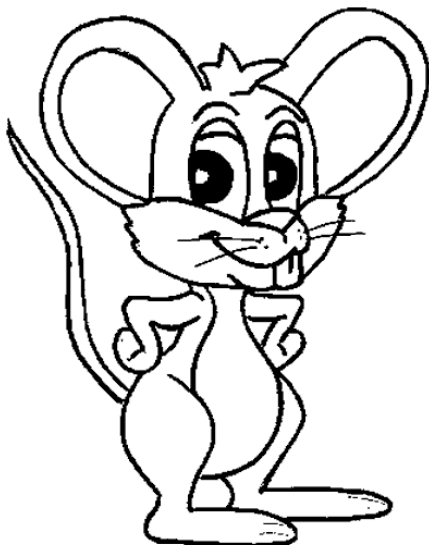
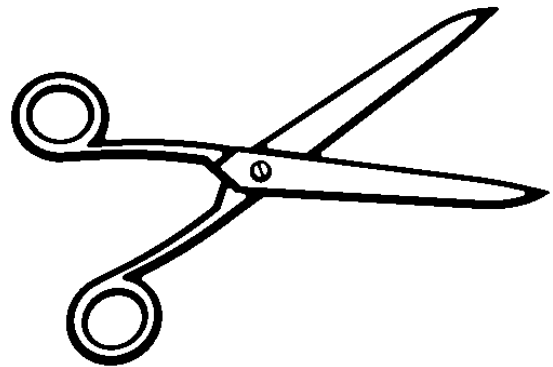
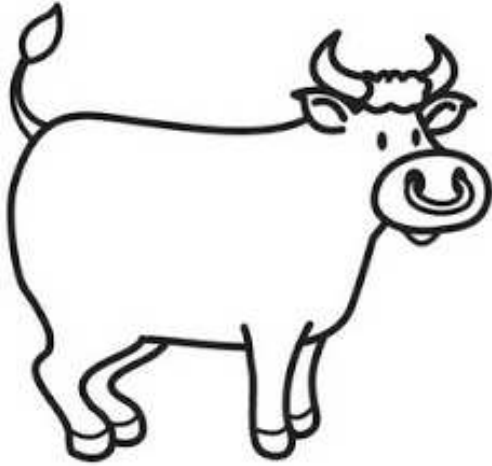



Rodea la palabra igual:

tela	tema	tela	tala	lata
tapa	pata	lata	tape	tapa
tema	meta	nata	tema	tala
tila	lata	tila	tima	pita
moto	Mote	tomo	moto	loto

Elige la palabra adecuada:

pelota

pato

patata

maleta

tomate

seta

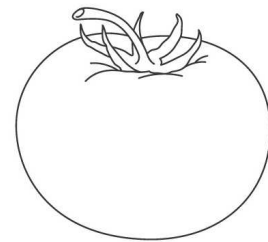

maleta

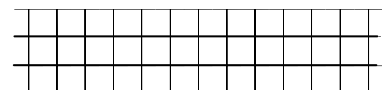
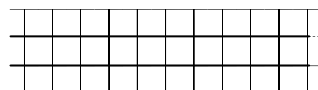
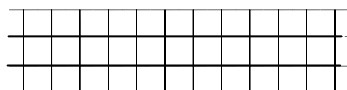
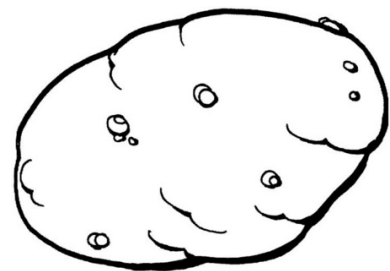
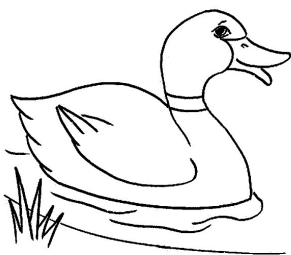
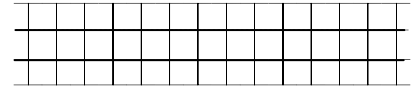
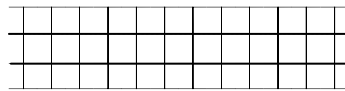

Repasa:

t t t t t t t t

t t t t t t t t

n n n n n n n n

n n n n n n n n

ta te ti to tu

ta te ti te tu



Repasa:

Ta Te Ti To Tu

Ta Te Ti To Tu

tiba tela tono tana

Tula tomate tana tos

Copia:

Tula se toma la tula.

Tomás tapa la mesa.

El tomate en la mata

Mi tío tuesta el pan.

Completa:

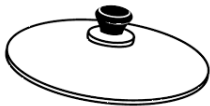

tapadera

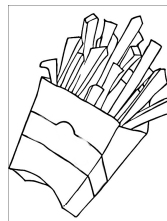

pa s



pas l



la

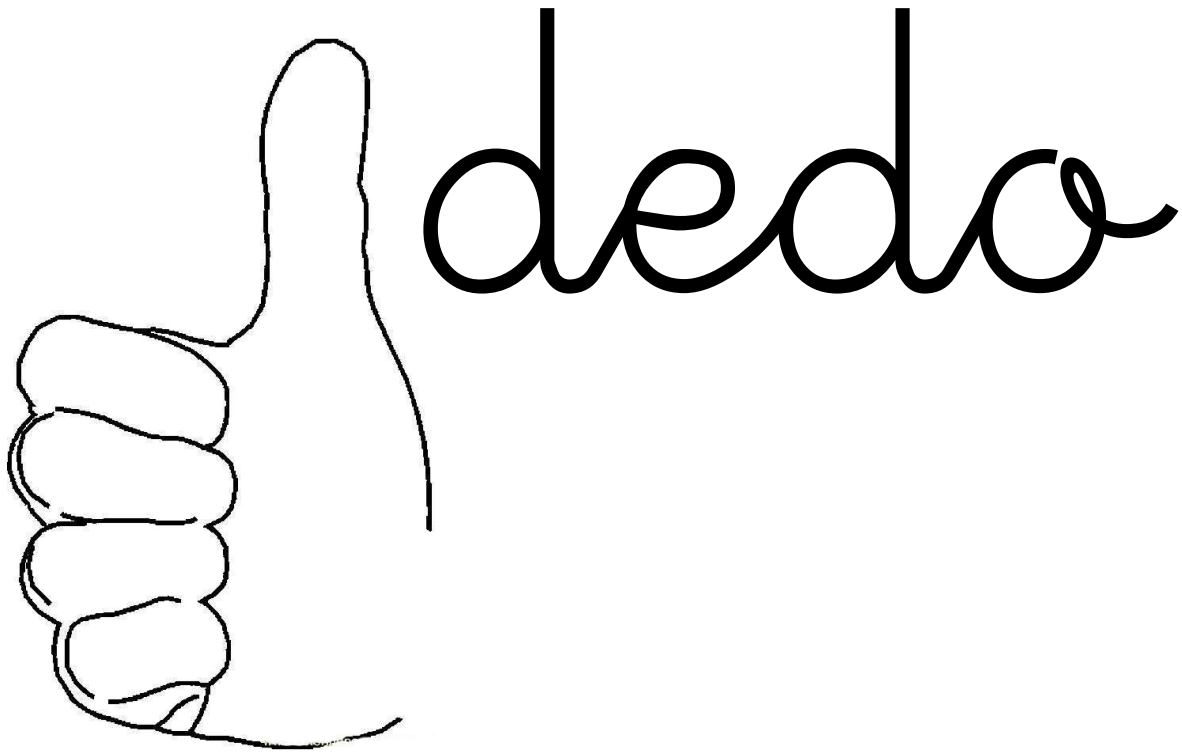



Pica

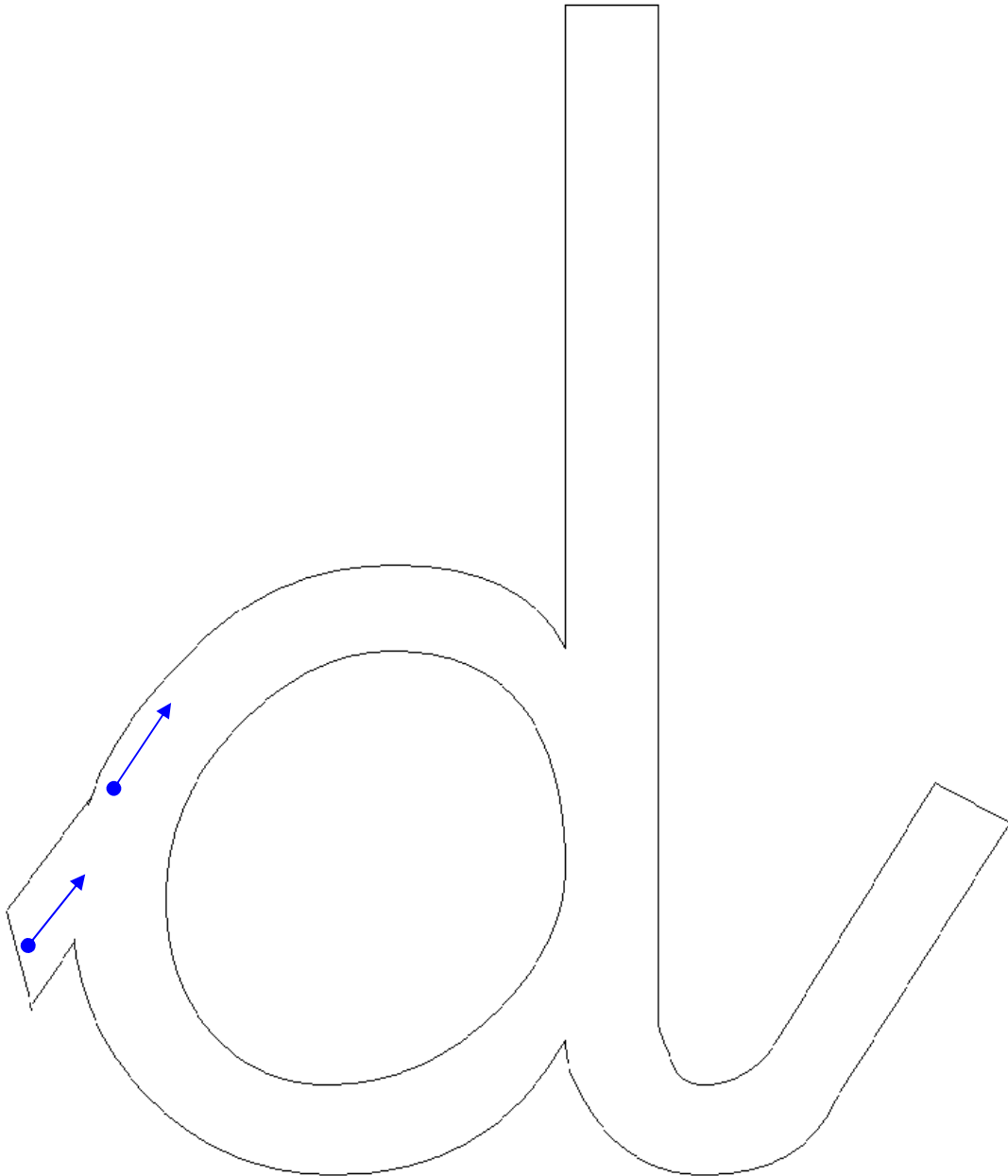



Colorea los dibujos cuyo nombre contenga el fonema "d"

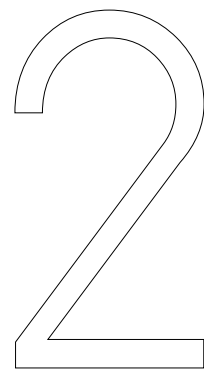
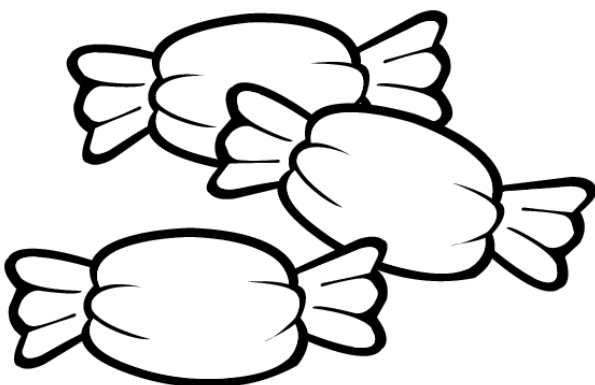
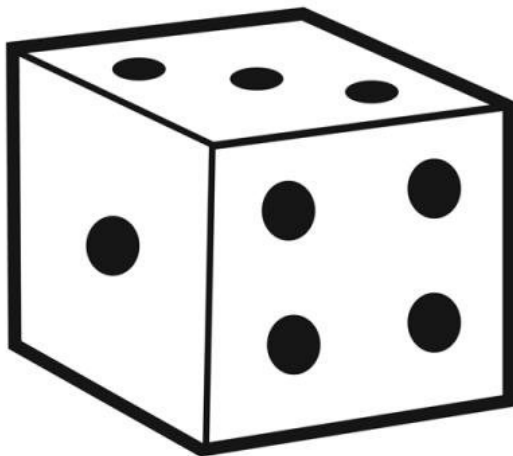

d

dddddddddd

d

d

D



Rodea la palabra igual:

mide	miedo	pide	mide	dile
adiós	dos	dios	dados	adiós
día	lía	día	mía	pía
dedal	dedo	dedito	dedal	dedos
duda	duda	suda	peluda	muda

Elige la palabra adecuada:

pomada

dálmata

dado

tostada

medusa

espada

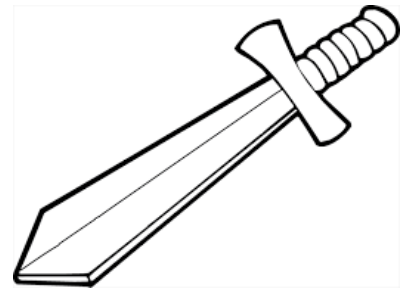
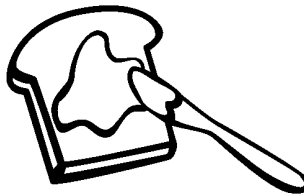
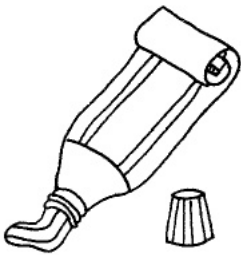

memada

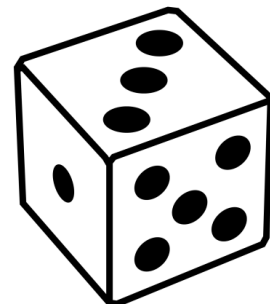
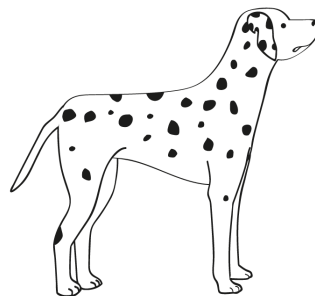
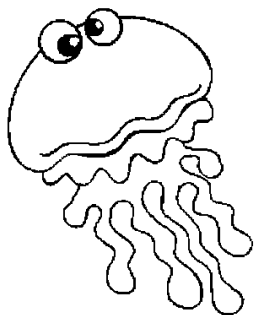

Lee, dibuja y copia.

siete dados

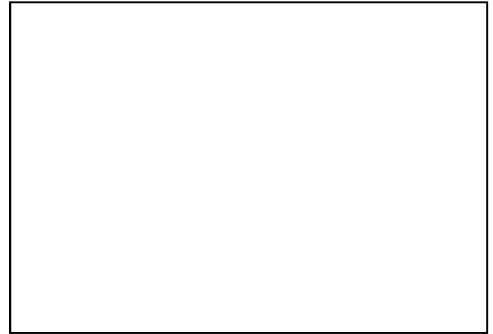

seis dedos



dos dedos



la nomada



Repasa:

d d d d d d d

d d d d d d d

D D D D D D D D D D D

D D D D D D D D D D D

da de di de du

da de di de du

Copia:

dedo dedal día duele

doy dama diadema

Dalia usa el dedal.

Damián saluda a Dael

Adela se da nomada

Me duele el dedo.

nube





Pica

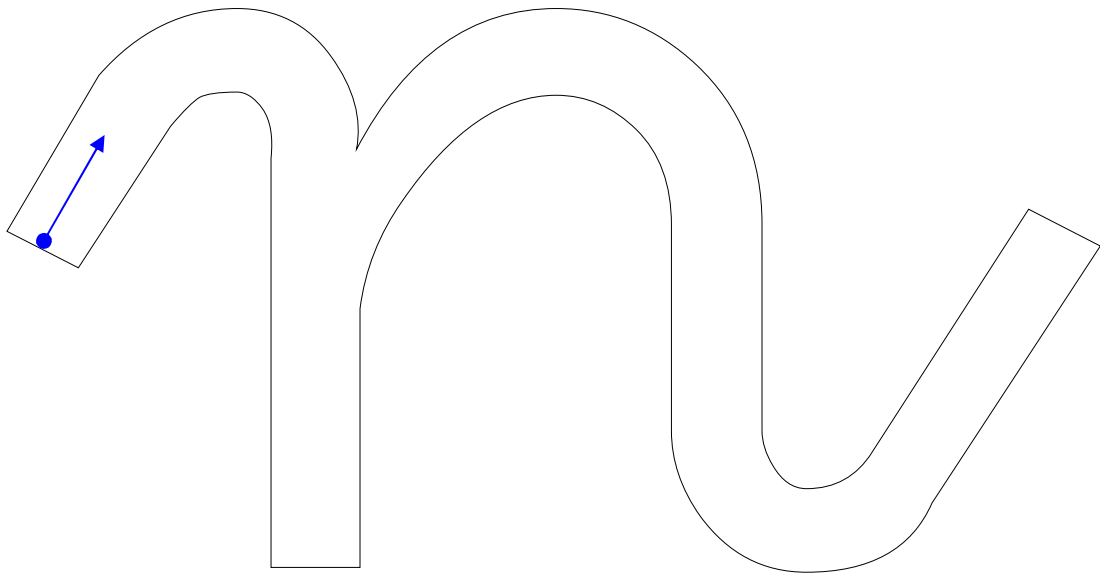





Colorea los dibujos cuyo nombre contenga el fonema "n"

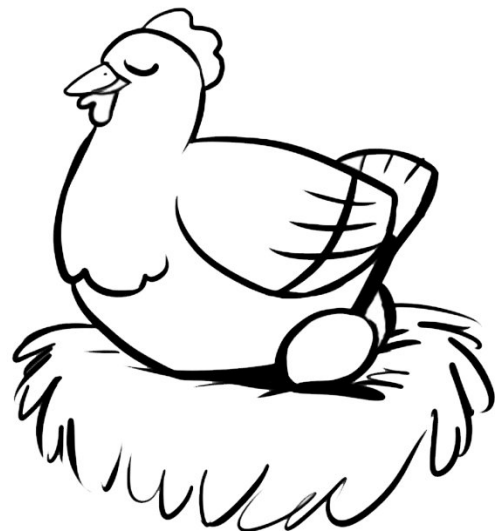
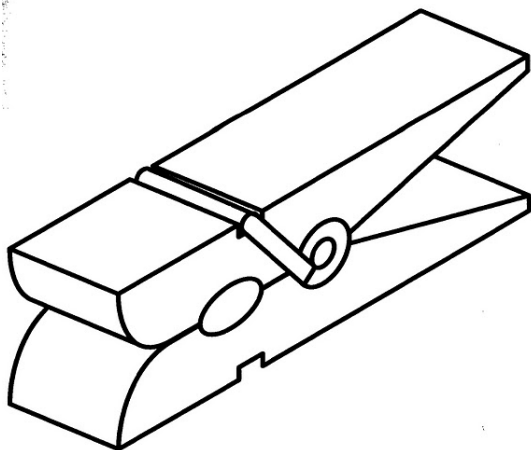
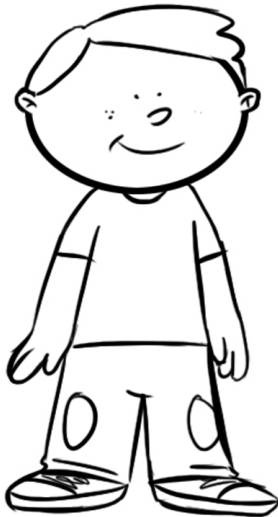

n

n n n n n n n n n n

n

n

N

Clasifica las palabras según su primera letra:

luna mano pan nido miel lana

pulpo nene mono piano nena león

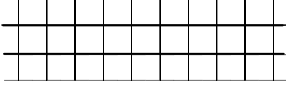
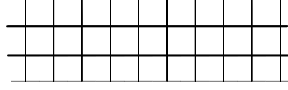
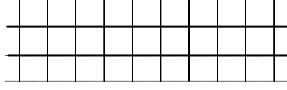
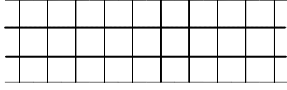
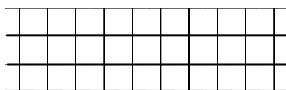
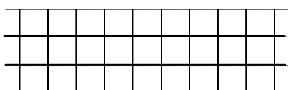
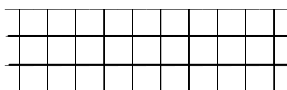
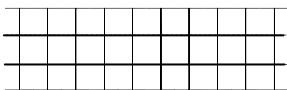
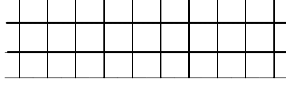
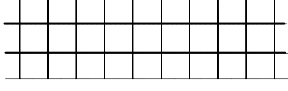
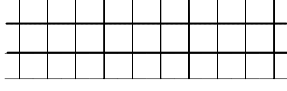
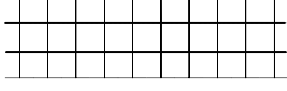
l	p	m	n
			
			
			

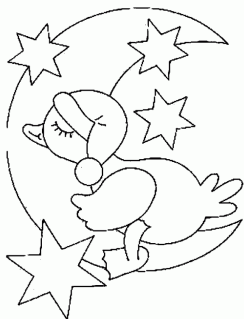

¿Dónde está el pato?

El n está

en la l

Lee estas palabras y escríbelas donde corresponda.

peine

nido

pan

piano

lana

pino

mono

luna

duende

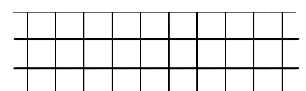
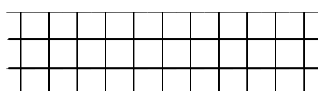
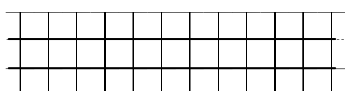
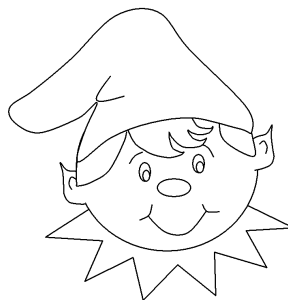
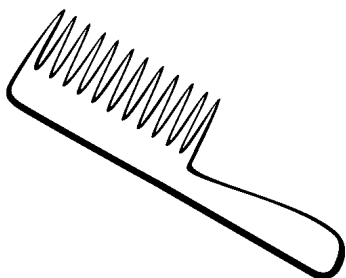
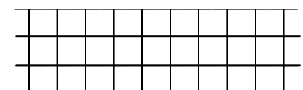
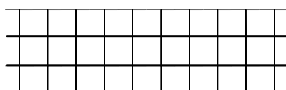
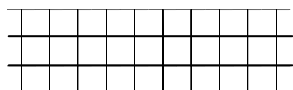
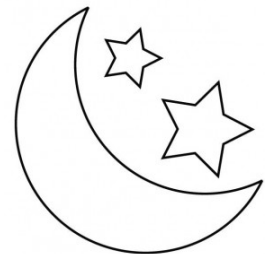
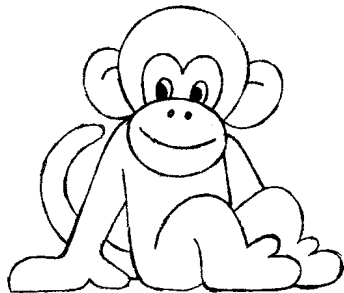
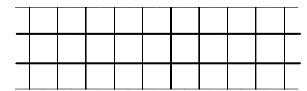
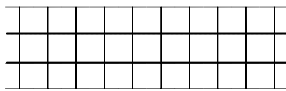
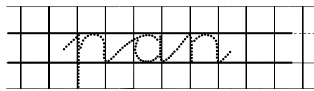
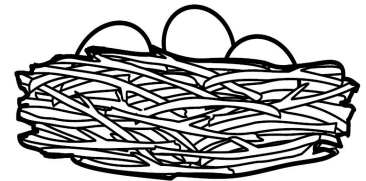
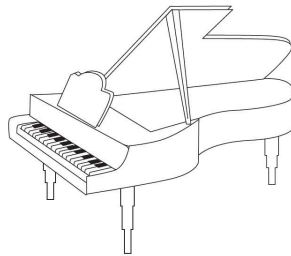
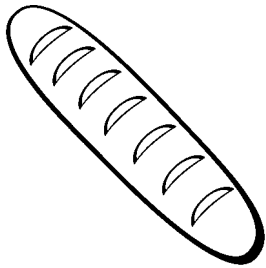

Repasa:

n n n n n n n

n n n n n n n

N N N N N N N N N N N

N N N N N N N N N N N

na ne ni no nu

na ne ni no nu

Repasa:

an en in on un

an en in on un

lana nana nino nan

lana nana nino nan

Paná nene el mantel

Nani usa sandalias.







Pica

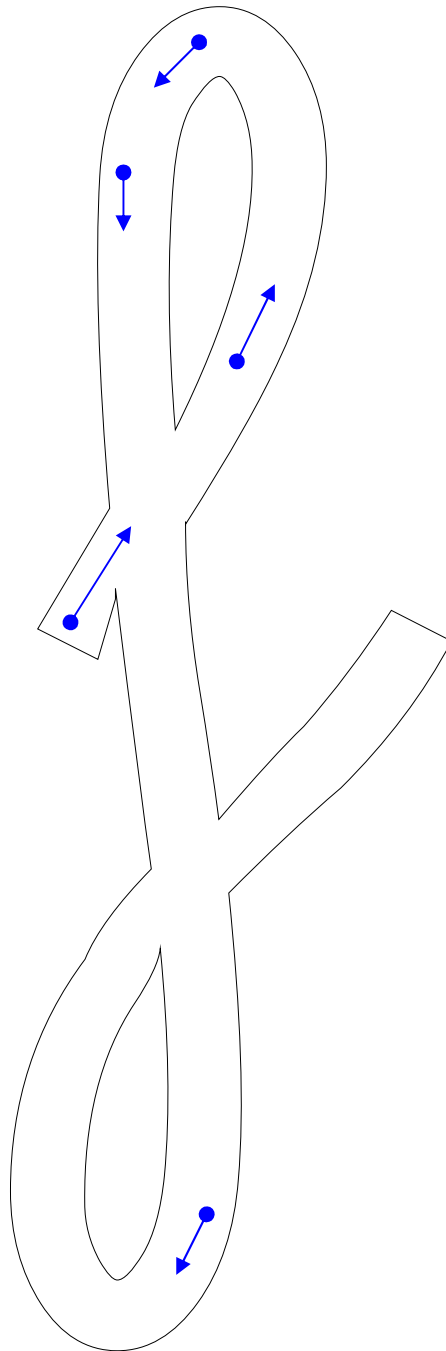



Colorea los dibujos cuyo nombre contenga el fonema "f"

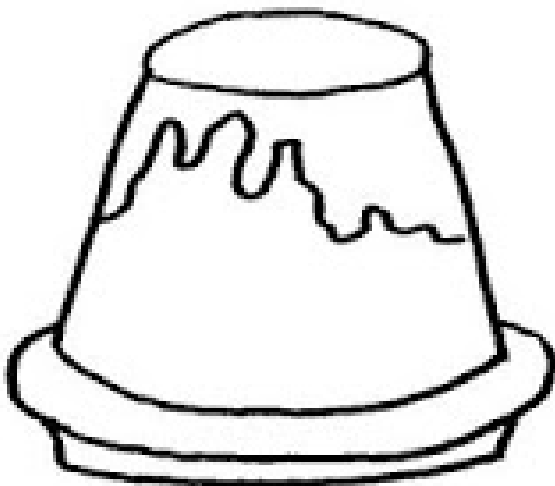
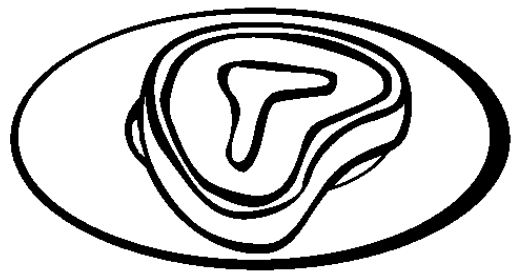
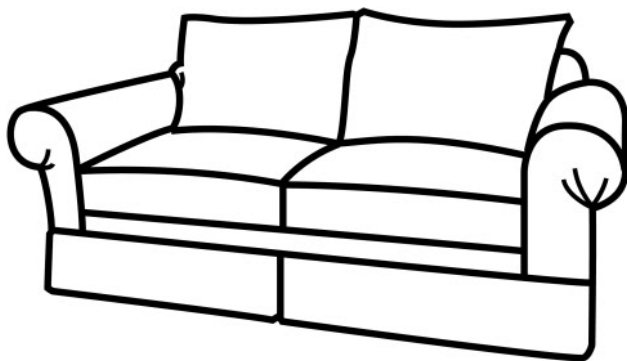
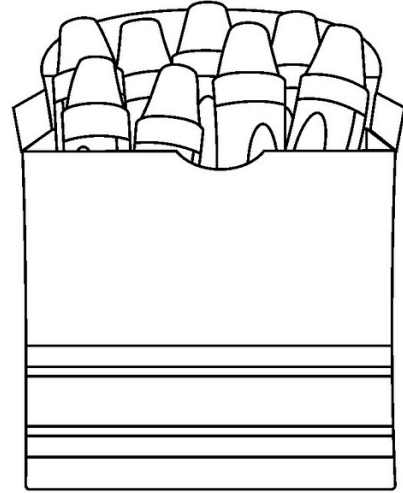





Escribe palabras con f:

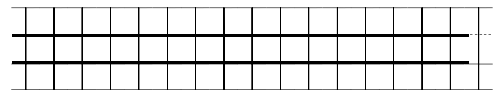
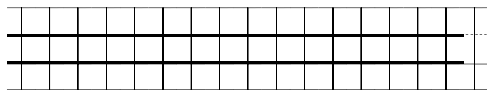
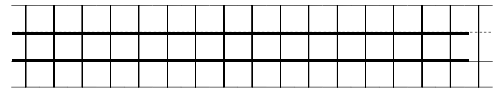
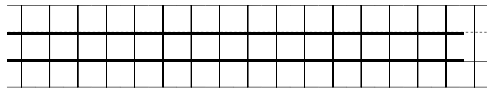
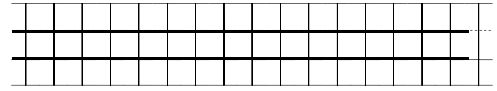
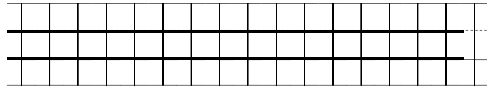

Lee y completa con f:

Elisa y Eline están

en la isla.

Lina salió muy era

en la oto.

Lina toma ban con

nata en el so-á.

Repasa:

f f f f f f f f f

f f f f f f f f f

□ □ □ □ □ □ □ □ □

fa fe fi fo fu

fa fe fi fo fu

Copia:

fotos fino fibete fama

fuentes familia teléfono

Fina sale en la foto.

Filo limpia la fuente.

Felipe está en fila.

Fátima es famosa.



hipopótamo

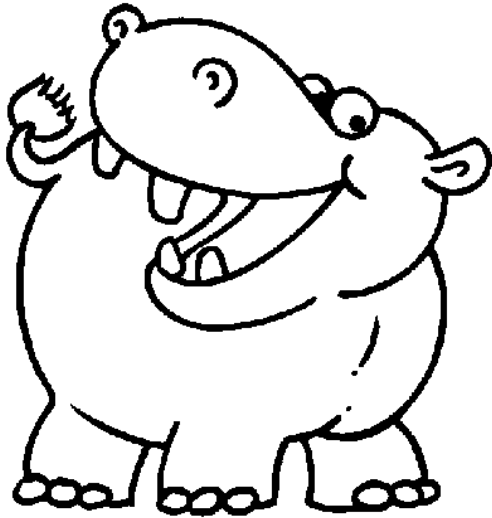



Pica

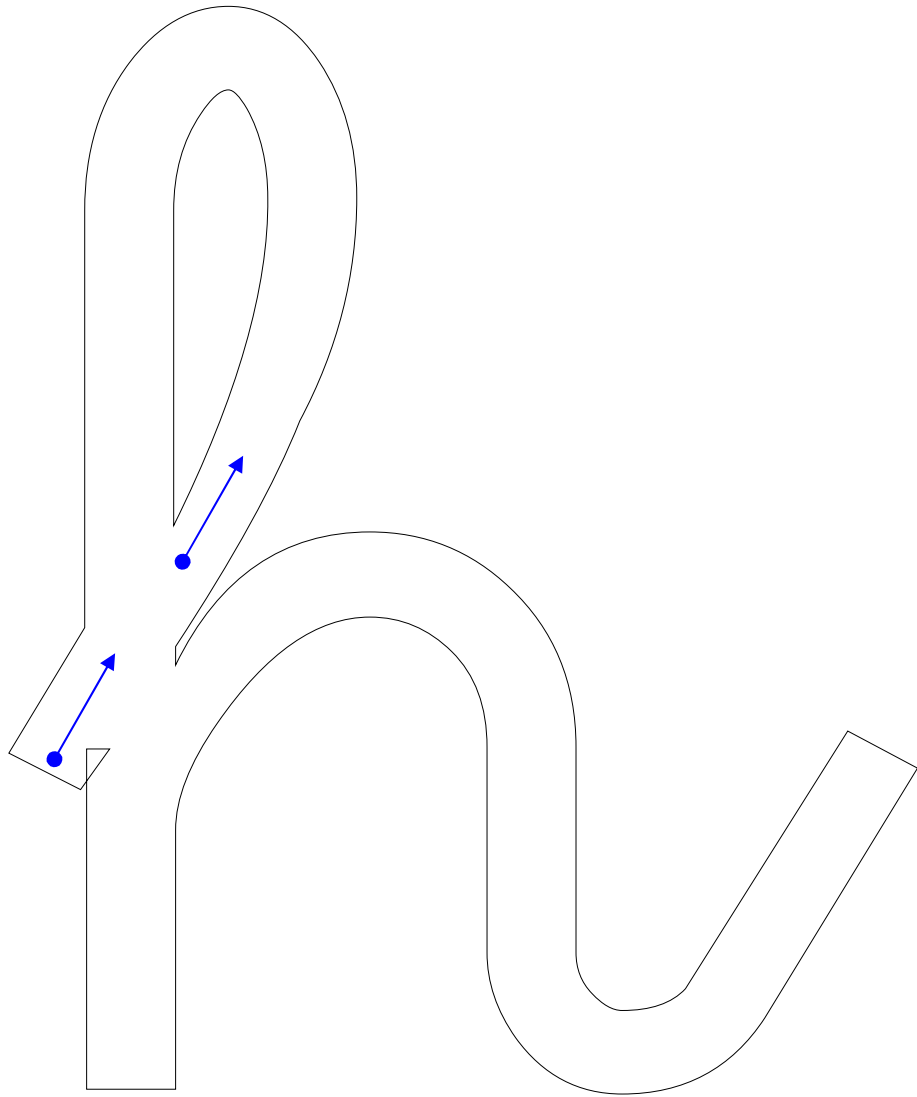



h

h h h h h h h h

h

h

H

Copia:



hada

hada

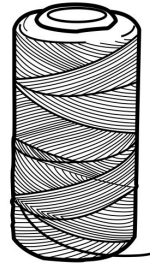

hilo

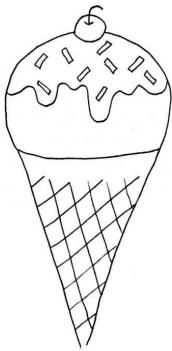

helado

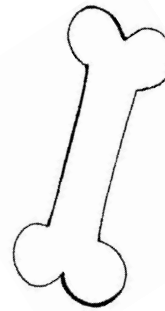

hueso

Lee y completa con h:

Dame el \_ielo.

La \_iena tiene \_uesos

La falda de \_ilo del

\_ada es muy fina.



Copia:

h h h h h h h h

h h h h h h h h

H H H H H H H H

H H H H H H H H

ha he hi ho hu



Copia:

hada hola hino hilo

Hilo almohada hoy hay

El hada tiene alas.

Ana ha tenido hino.

Patina en el hielo.

Ha olido el humo.

Busca en la sopa de letras:

f	o	m	p	n	a	p	u
i	e	l	e	s	t	u	n
l	m	s	i	l	m	l	p
e	u	a	n	l	s	p	o
t	p	o	e	a	l	o	s
e	s	p	a	l	d	a	d
h	e	l	a	d	o	f	l
a	l	m	o	h	a	d	a

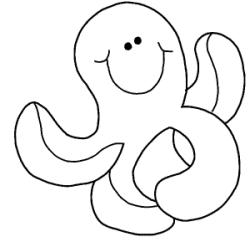

muñeco

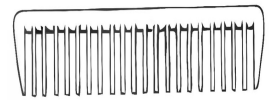

peine

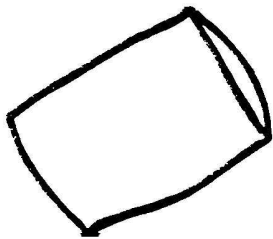

almohada



esnaldada



flor de cañuto



helado

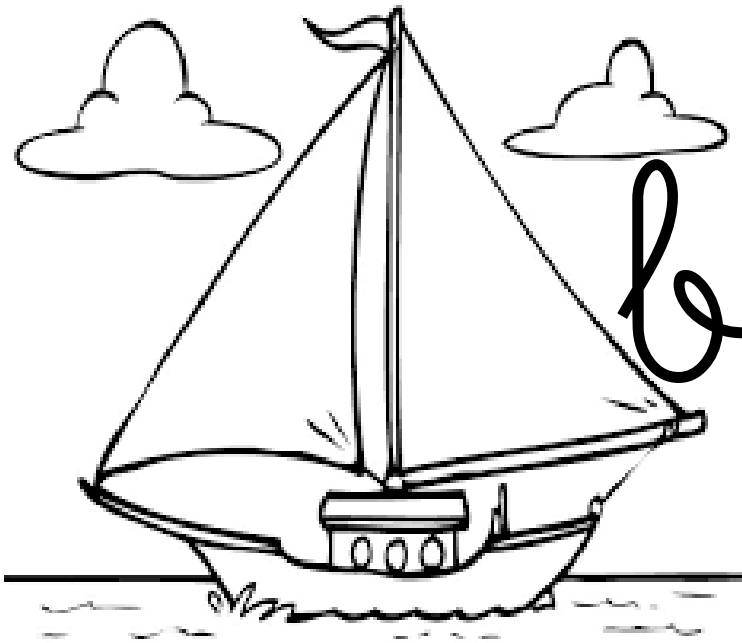

barco



Pica

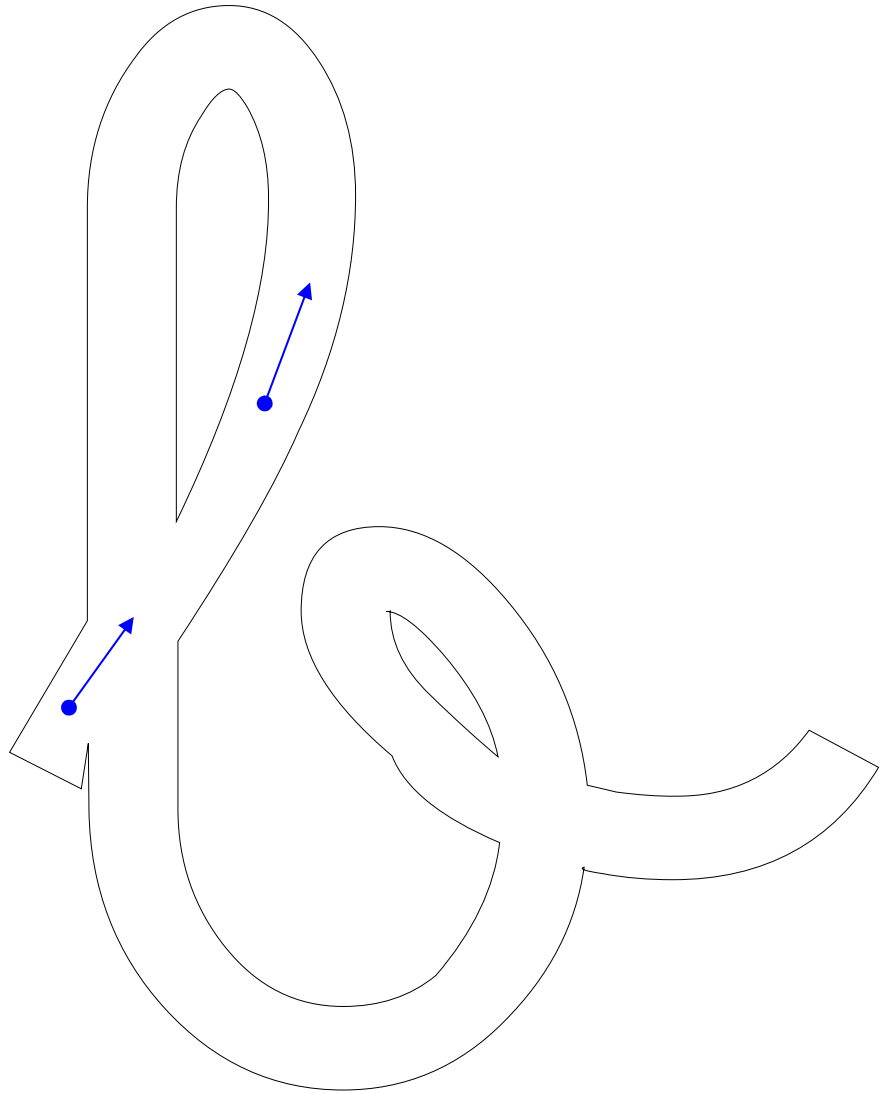



Colorea los dibujos cuyo nombre contenga el fonema "b"

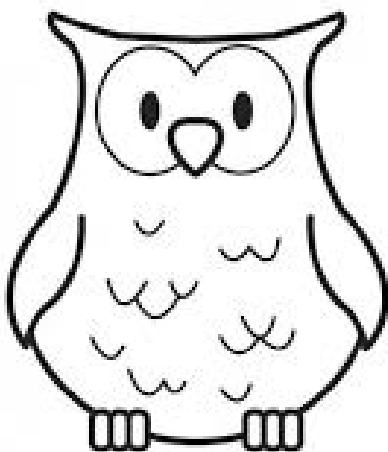
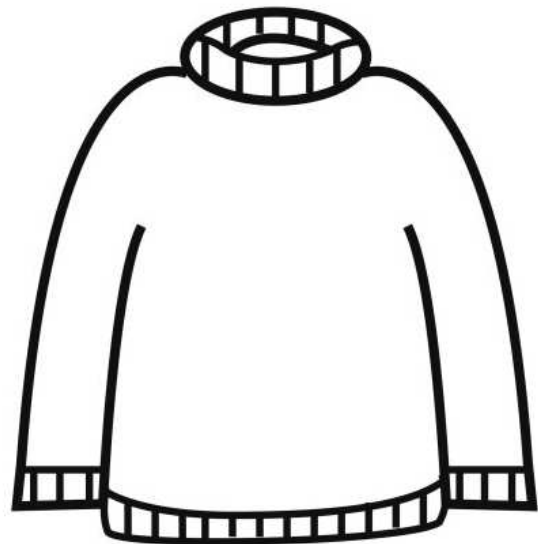
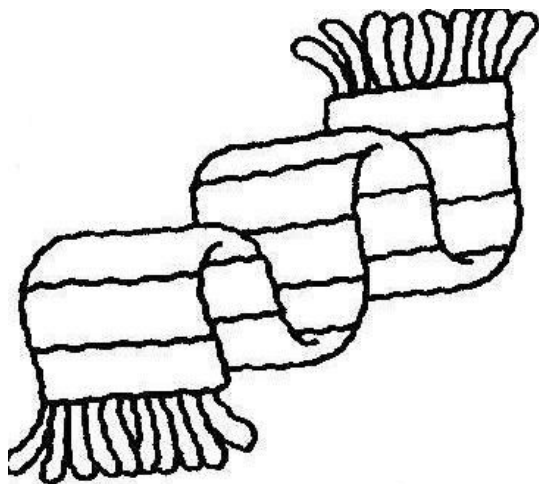
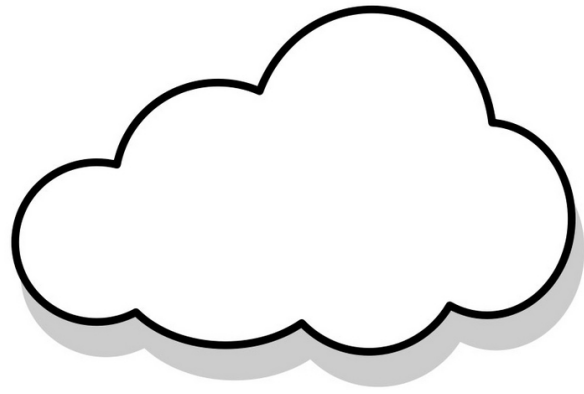
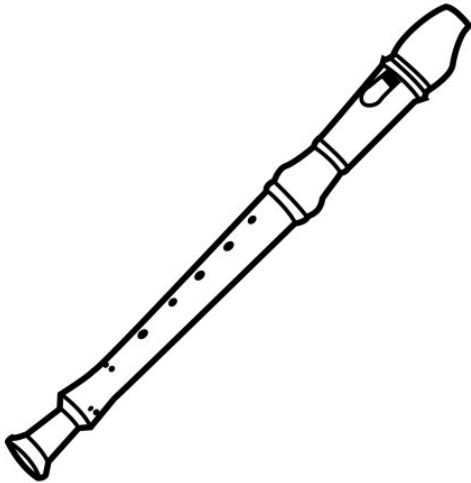

b

b b b b b b b b

b

b

B



Rodea la palabra igual:

bebé	baba	boba	bebé	beba
bebo	bebe	bebo	baba	beba
boda	boda	boba	debo	bebo
bola	lobo	bolo	boba	bola
bota	bola	bota	boda	bote

Elige las palabras adecuadas:

batido      bufanda      bebé      bote

bobo      abuelo      nube      lobo

autobús      bota      bolos      abuela

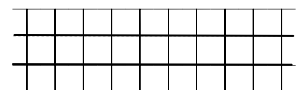
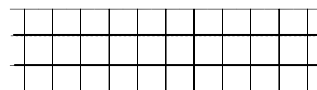
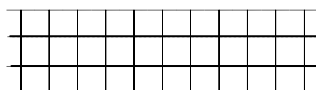
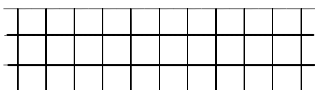
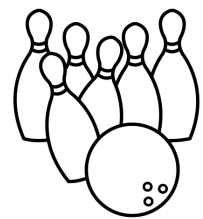

Une con flechas y copia:



abuelos

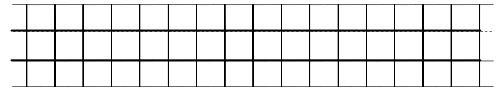

beso

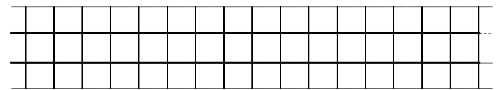

bolso

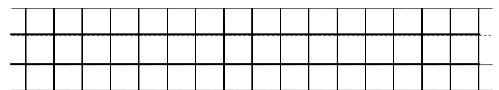

balón

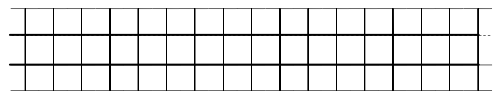

Lee y completa con b:

Benta \_ e \_ e un \_ atido.

Benito lee un te \_ es.

Bea toma \_ om \_ ones.

Fa \_ io tiene un \_ úho.

Repasa:

b b b b b b b

b b b b b b b

B B B B B B B B B B B

B B B B B B B B B B B

ba be bi bo bu

ba be bi bo bu

Copia:

bebé besa baba bola

bonito buena abuelas

Alba tiene una bata.

Bebén lee un libro.

Benito bebe limonada.

Mi abuela me besa.